

JEAN PIERRE PETIT

HUMOR DEL MAS ALLA

HUMOR EN 'EL BOSQUE'

DIBUJOS

26 jun. 1990

Pom Antonio Rubera



Jean Pierre Petit

HUMOR

DEL MAS

ALLÁ

JEAN-PIERRE  
PETIT

EN NOMBRE DE  
MI GOBIERNO

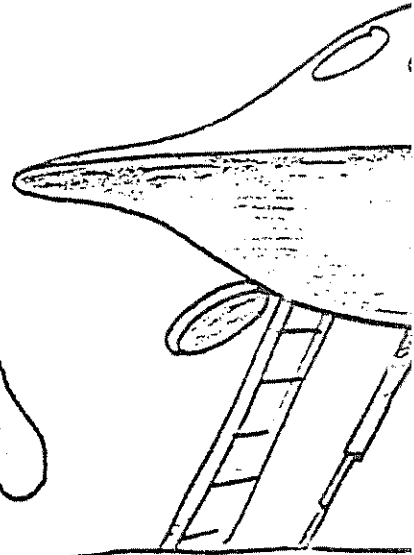
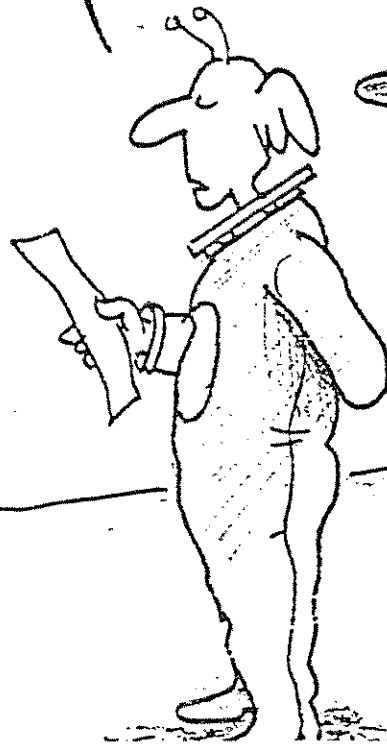
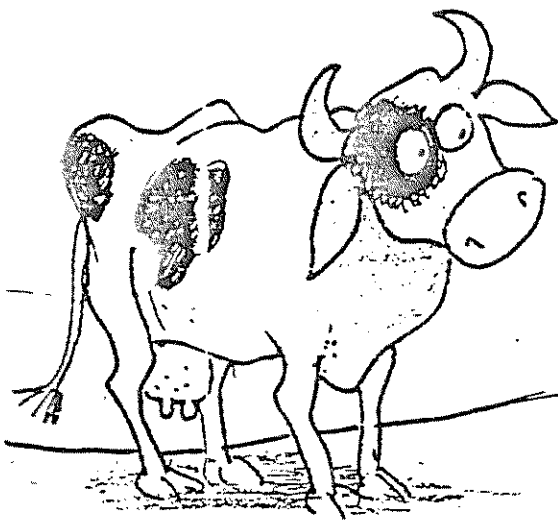

NO HABEIS PUESTO LOS  
AMPERIOS NECESARIOS  
PARA EL DESPEGUE

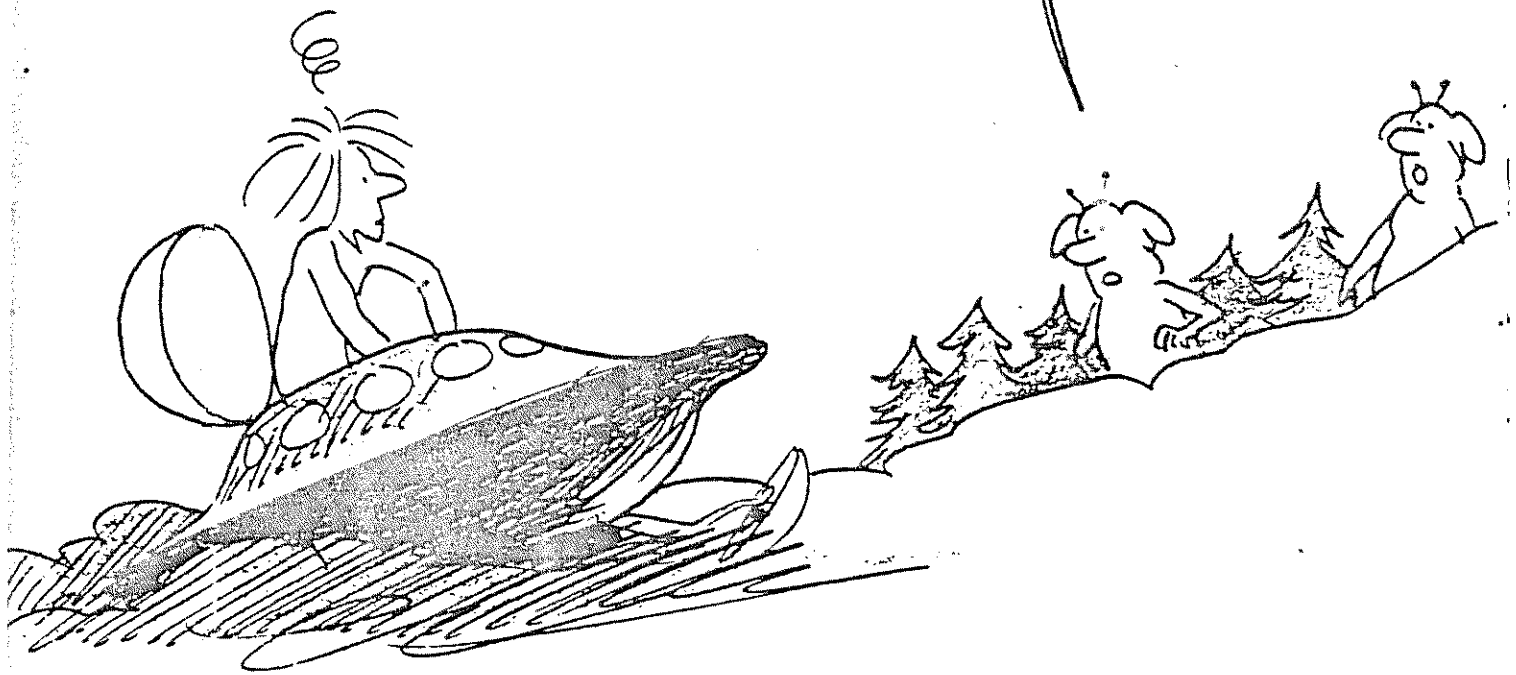

CONTINUA YA  
ENCONTRAREMOS LAS  
LLAVES

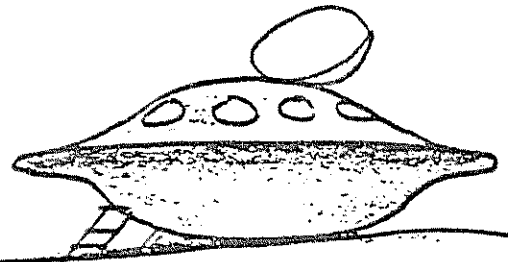
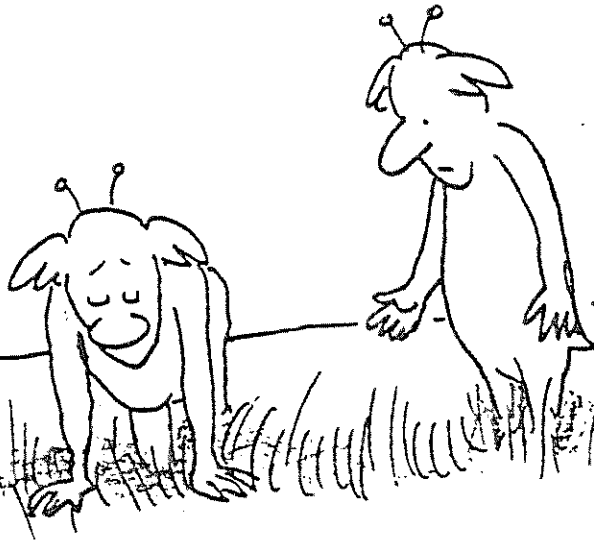



TIRO AL PLATO

VEN NOS  
VOMOS INMEDIATAMENTE !!

NO ME CONTRADIGAS  
VAMONOS YA !!!  
...

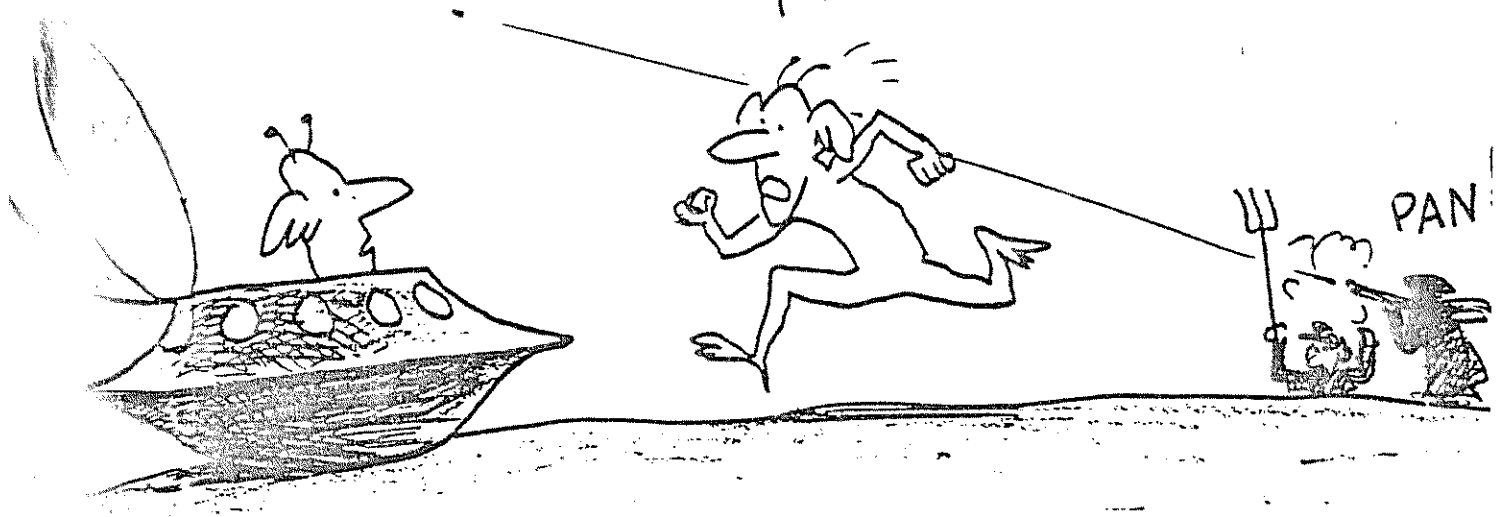

ES EXTRAORDINARIO!!  
EL TESTIGO HA LLEGADO A  
CREAR UN OBJETO REAL  
ATRAVES DE SU IMAGINACION.

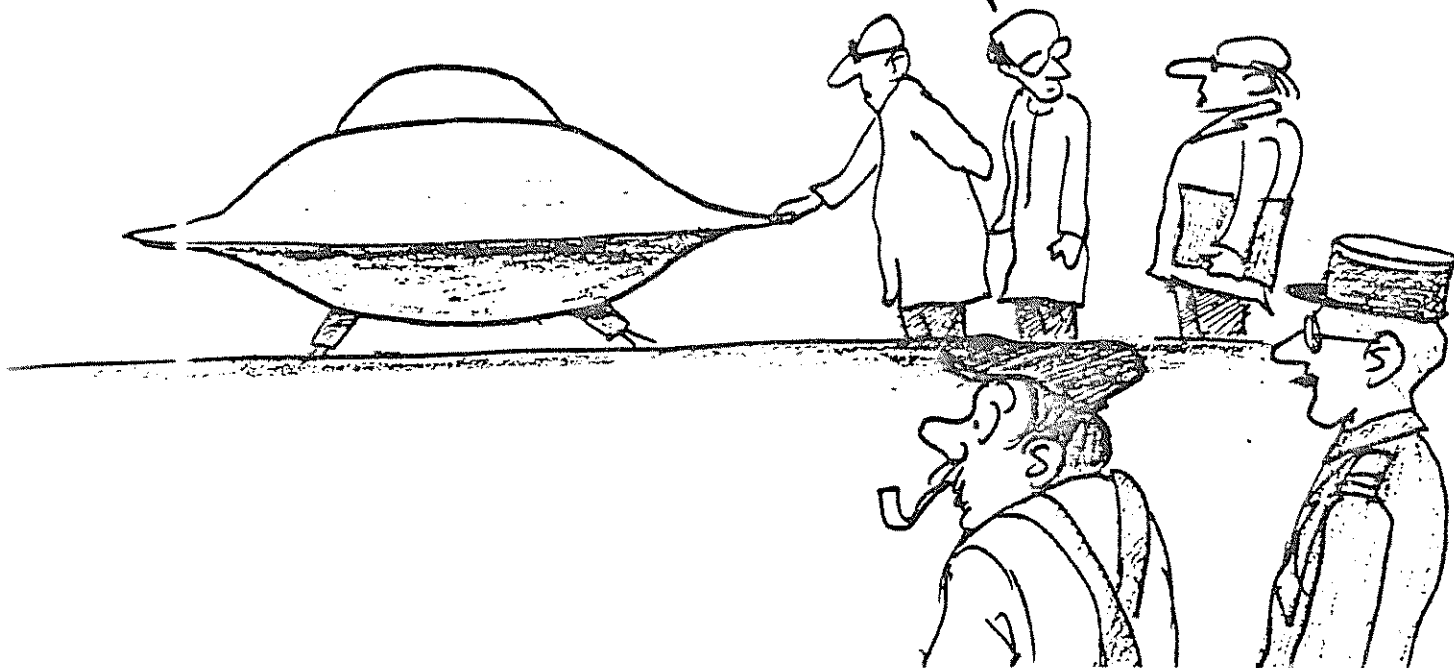



Jean Pierré

El Sabio dice: ¡No existen...!



LABORATORIO  
CIENTIFICO

YA LE HEMOS  
DICHO QUE NO!

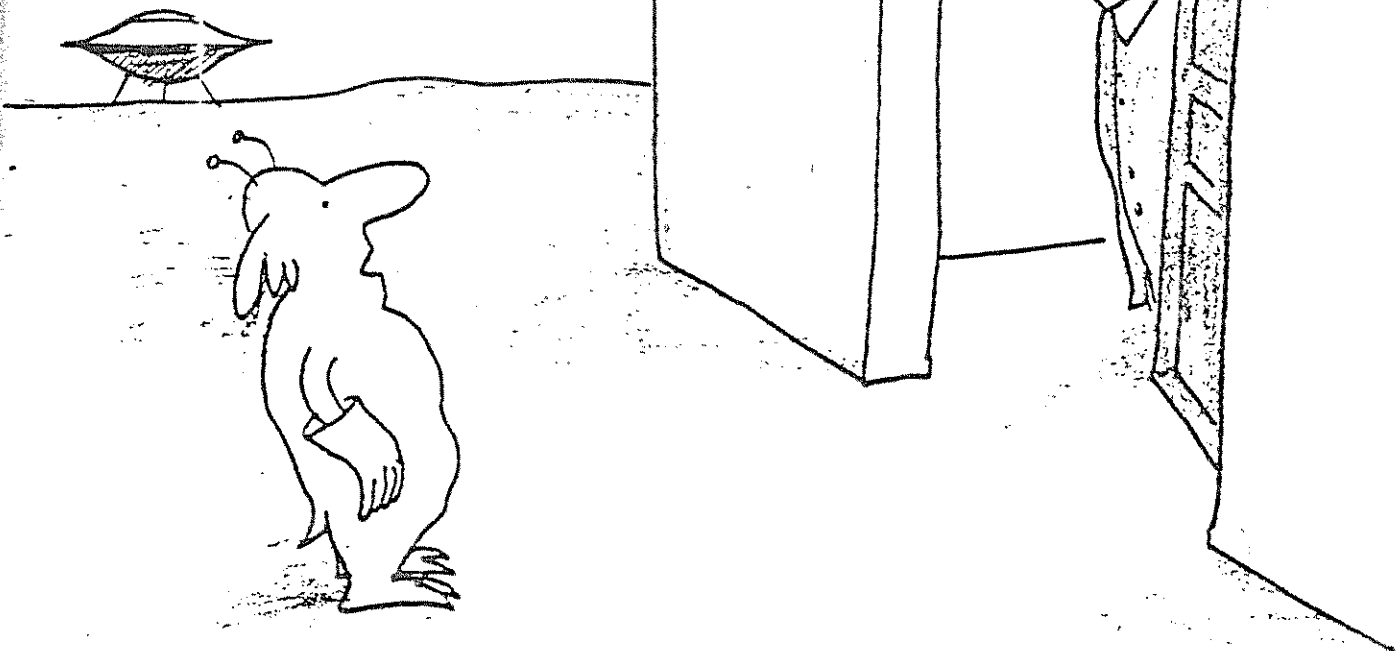

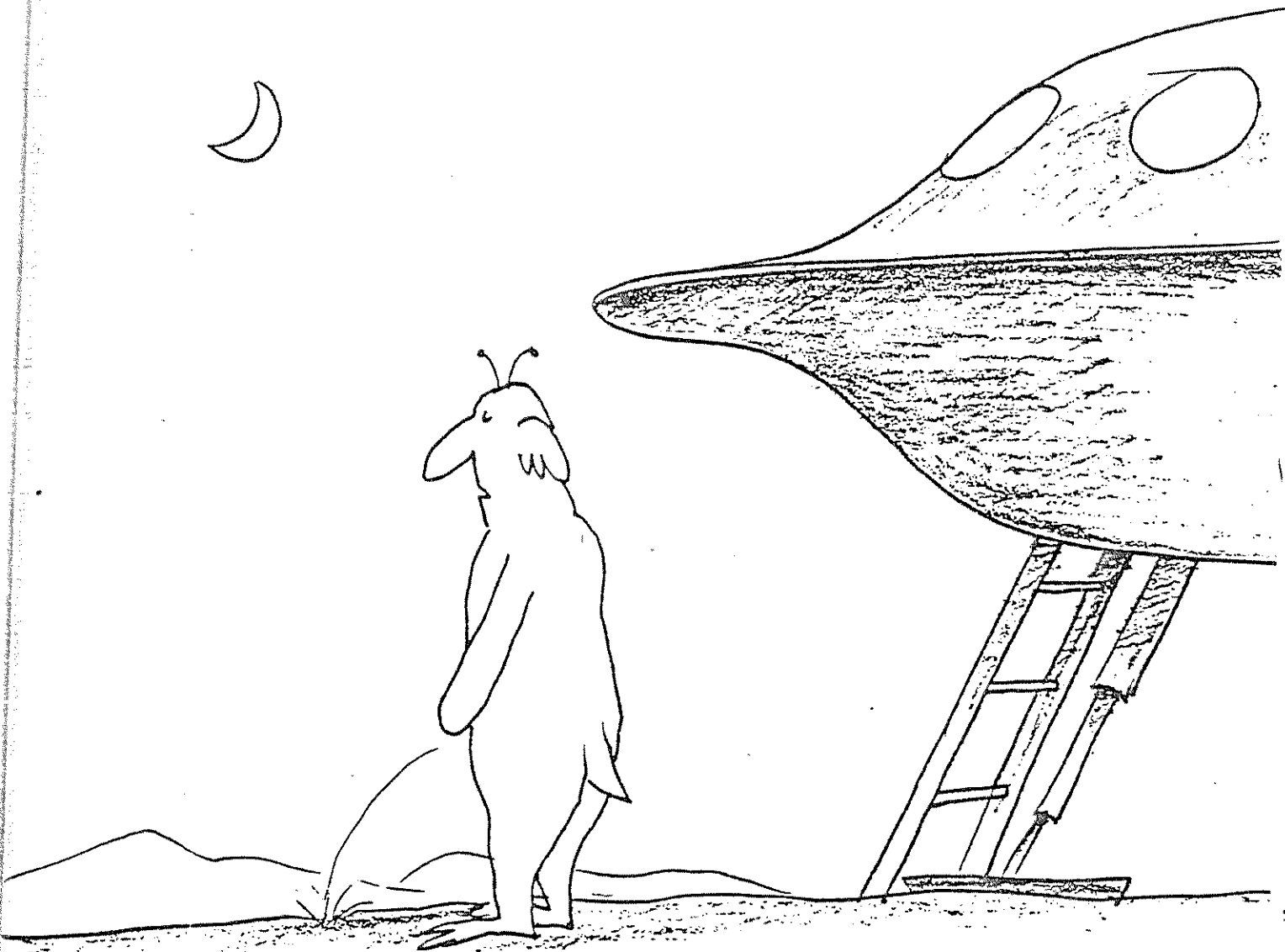

NO HAY QUE CONCLUIR  
DEMASIADO A PRISA

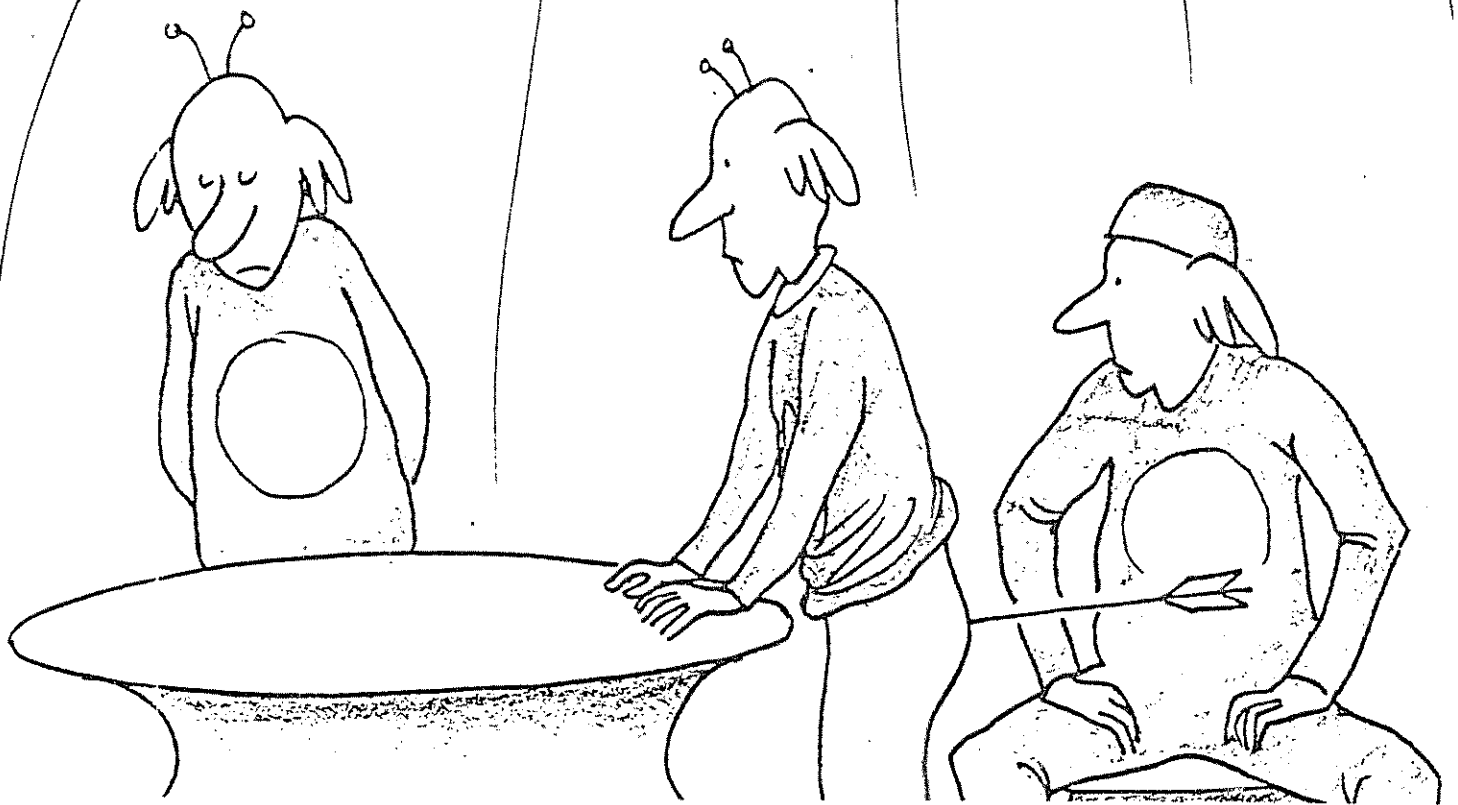

HABEMOS CAIDO EN PANA  
~~EN~~ A ALGUNOS KILOMETROS  
DE AQUI



SI, UN  
CORTO CIRCUITO  
POR CAUSA DE HUMEDAD

Juan P. en  
Relet

¿VUESTRAS INVESTIGACIONES  
HAN TRAI DO CAMBIAMIENTOS  
EN VUESTRA VIDA ?



Jean Pierre Petit

OH! COMO HACEN  
PARA COMERSE ESAS  
COSAS!

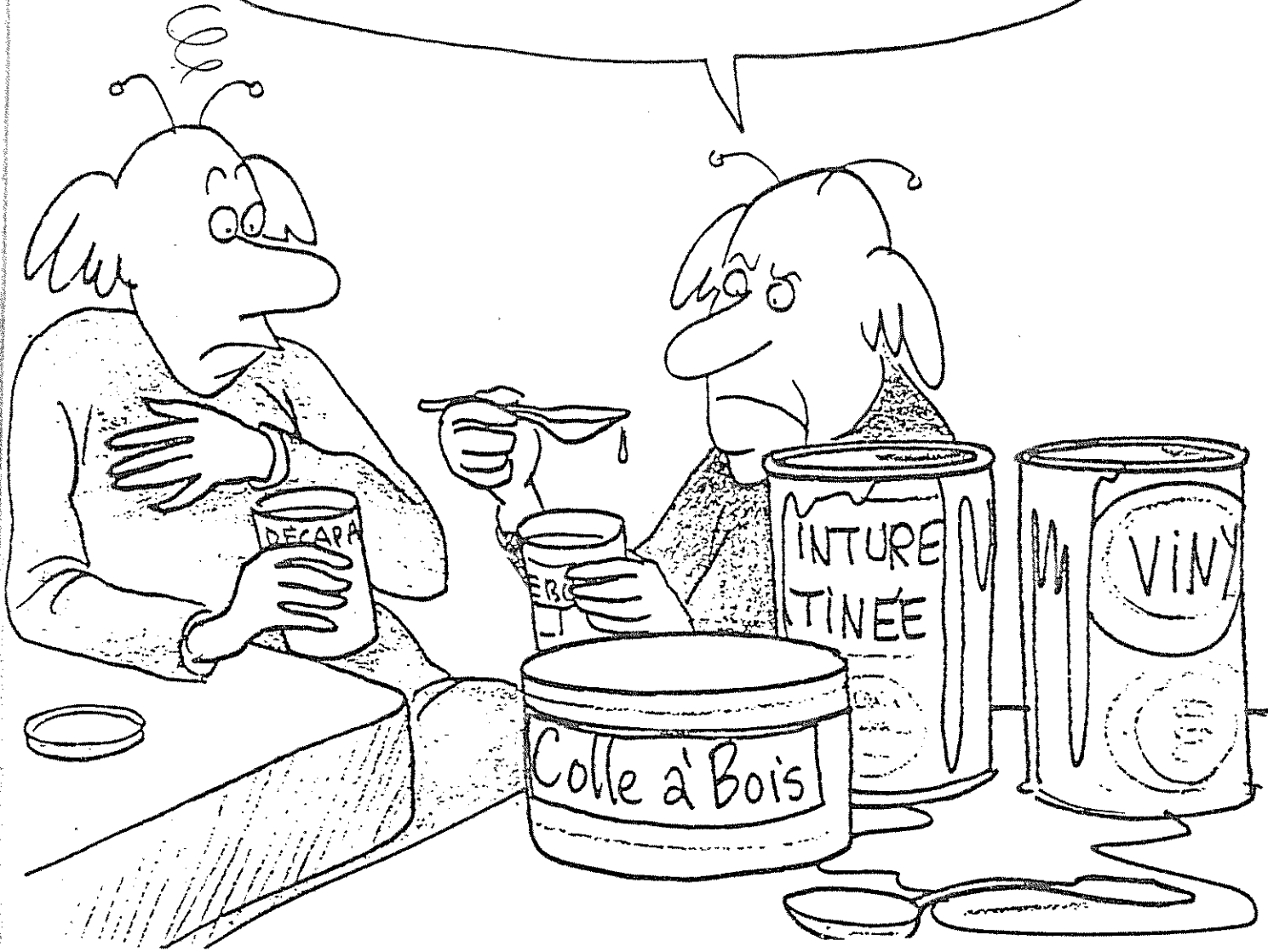

Y AHORA MI CAMARADA  
VA HACER LA DEMOSTRACION  
DE ESTA EXTRAORDINARIA  
MAQUINA VOLANTE.

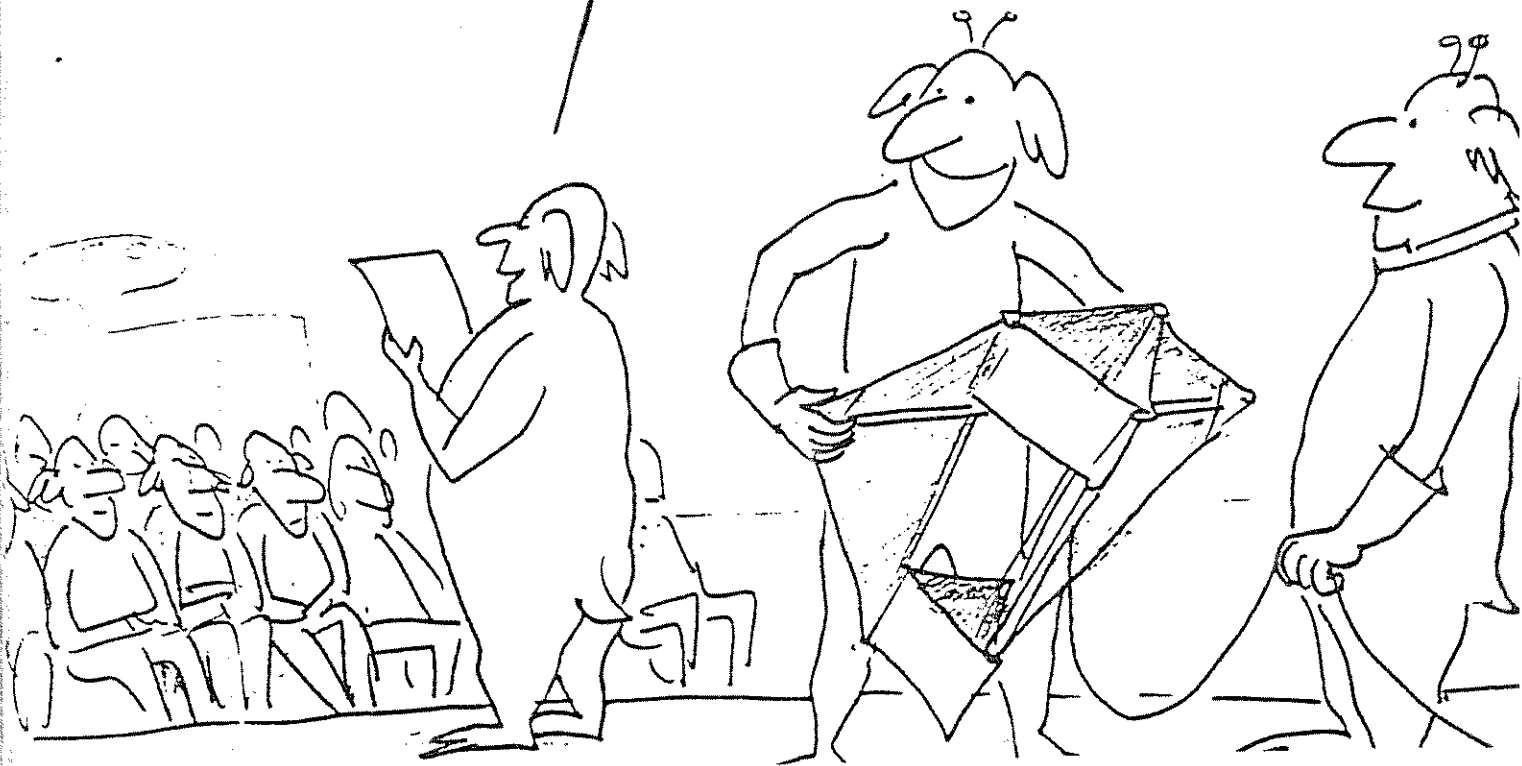

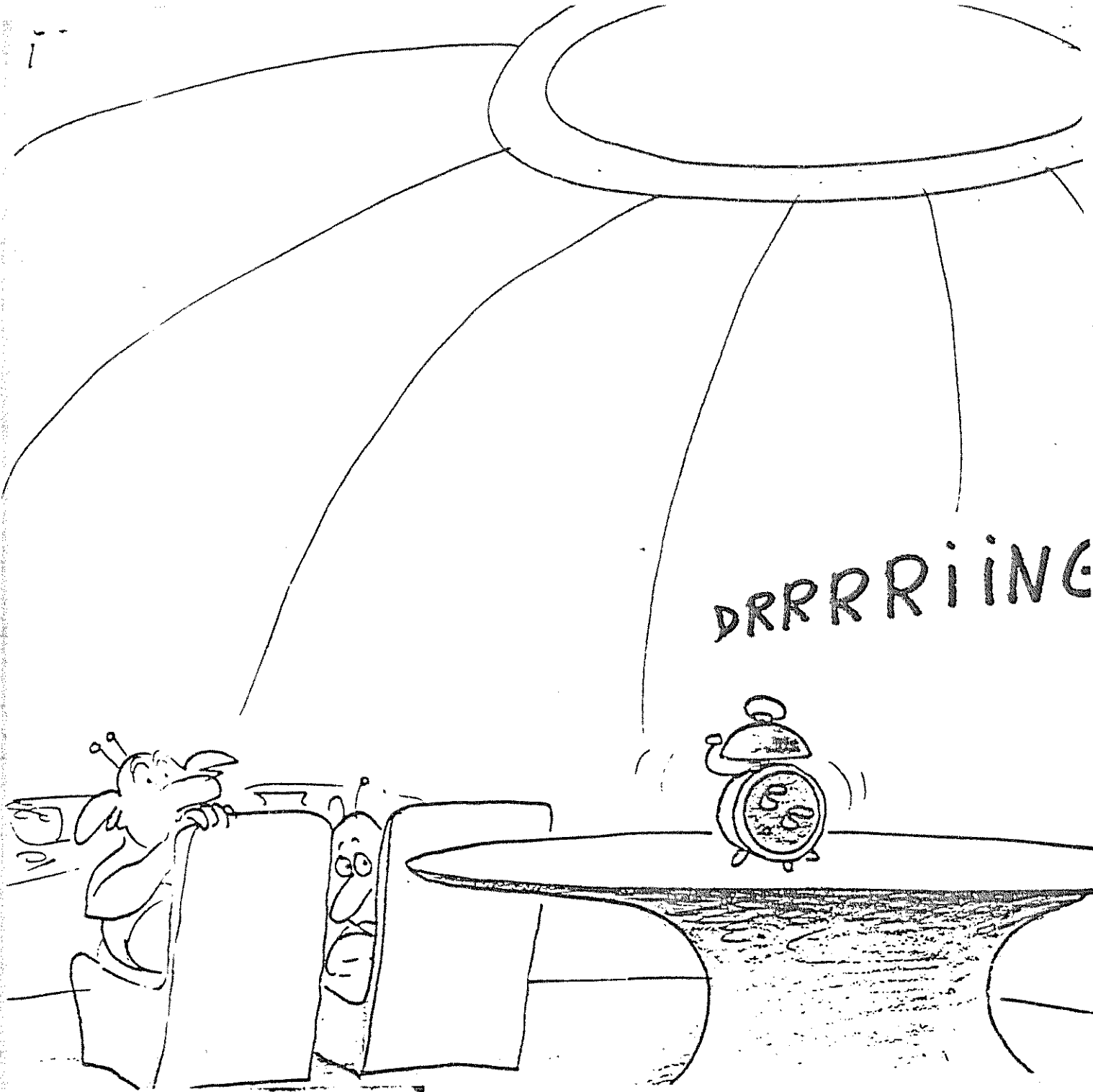

DRRRRING



Y MICHEL PASA  
A BUITRAGUEÑO Y  
.....

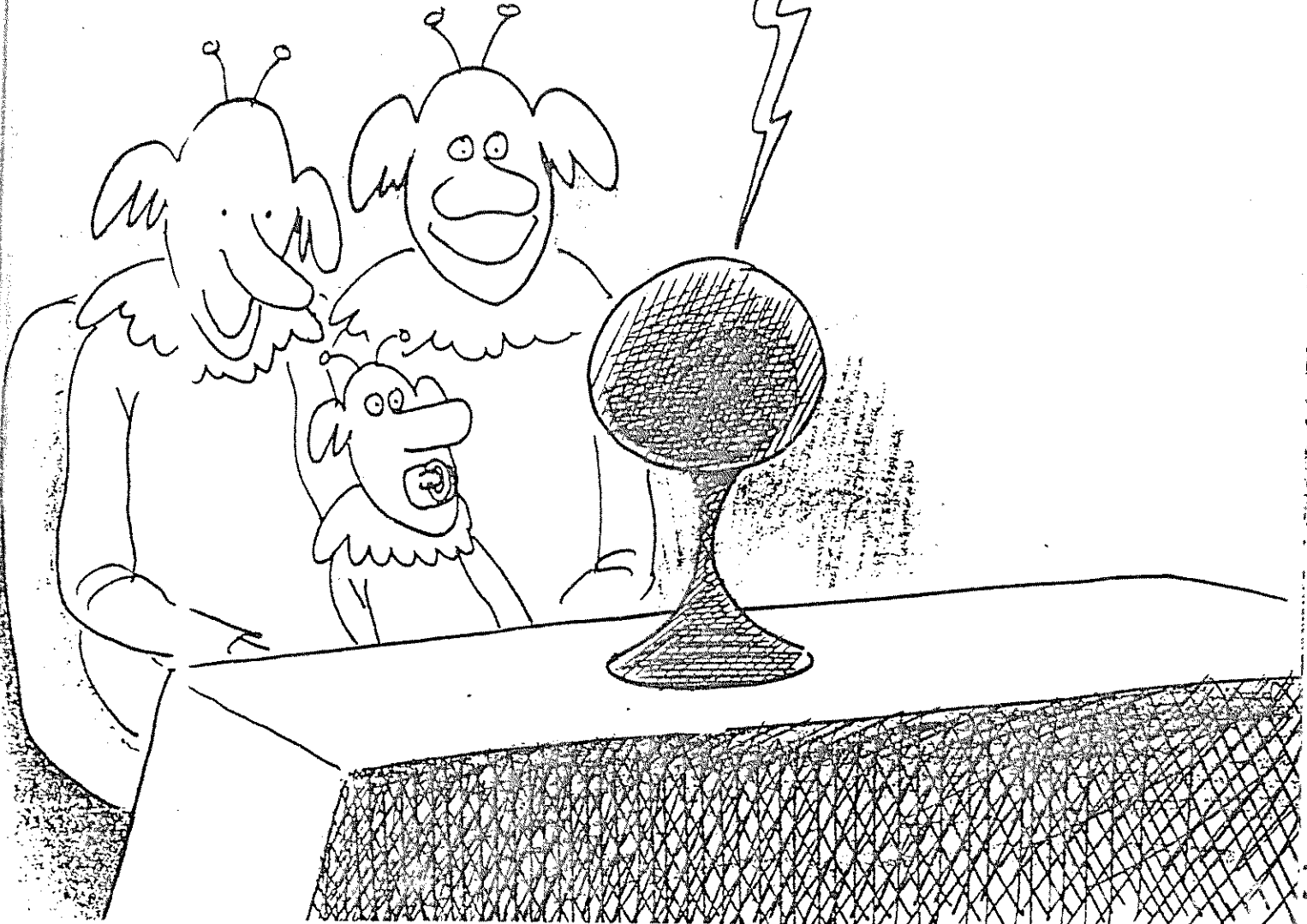

ESTAMOS SEGUROS  
DE QUE ESTAMOS  
SOLOS EN EL  
UNIVERSO

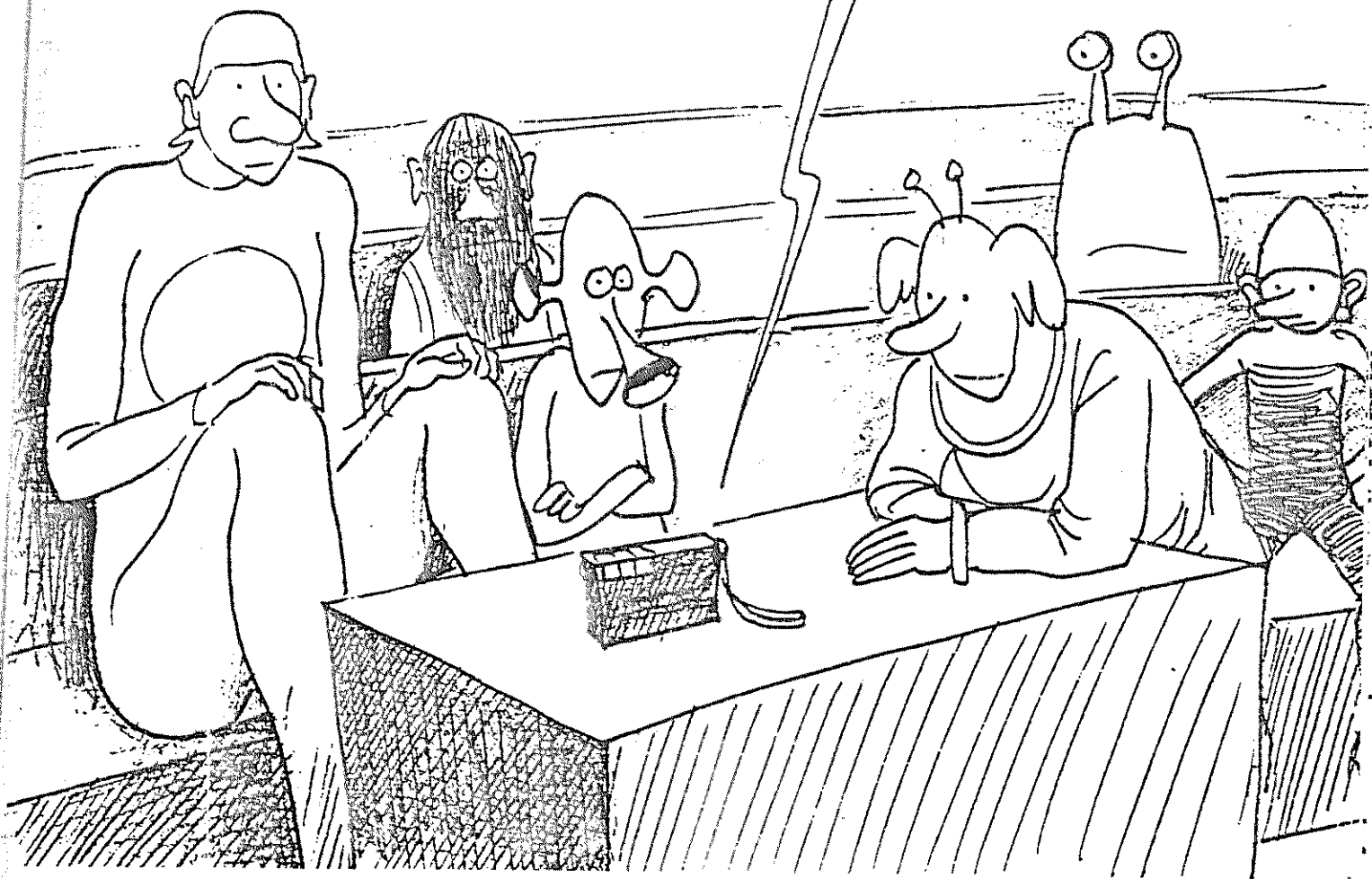

SON HORROROSOS !!



NOS LLEVAREMOS ESTO PARA  
NUESTRAS PELICULAS DE HORROR



HE DE CONFESARLE QUE NO  
SOY REALMENTE UN AGENTE  
DE SEGUROS

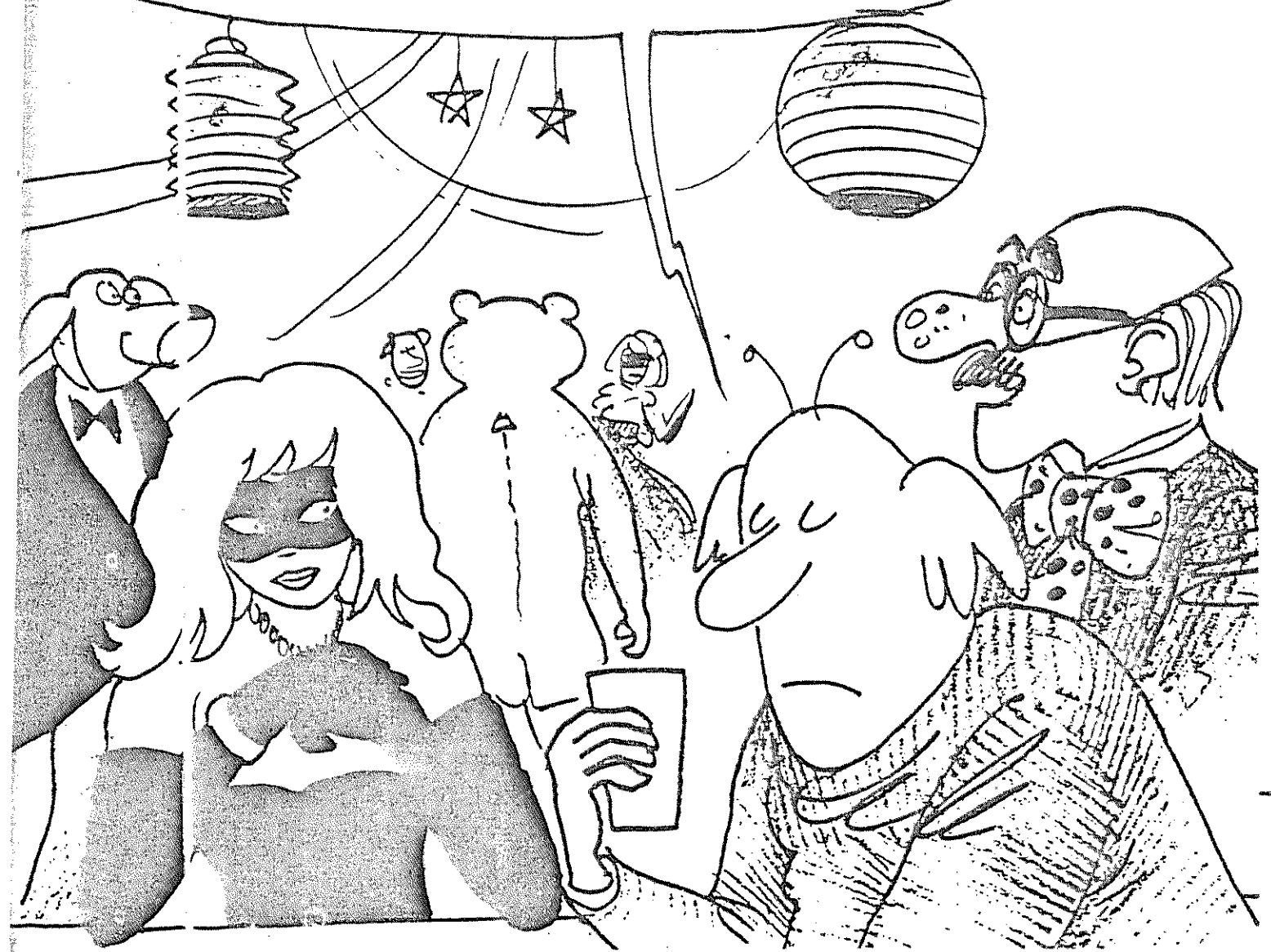

NO COMPRENDO DE QUE SE RIEN  
HIEMOS HECHO LOS TRAJE COMPLE-  
TAMENTE IGUALES QUE EN LOS LIBROS



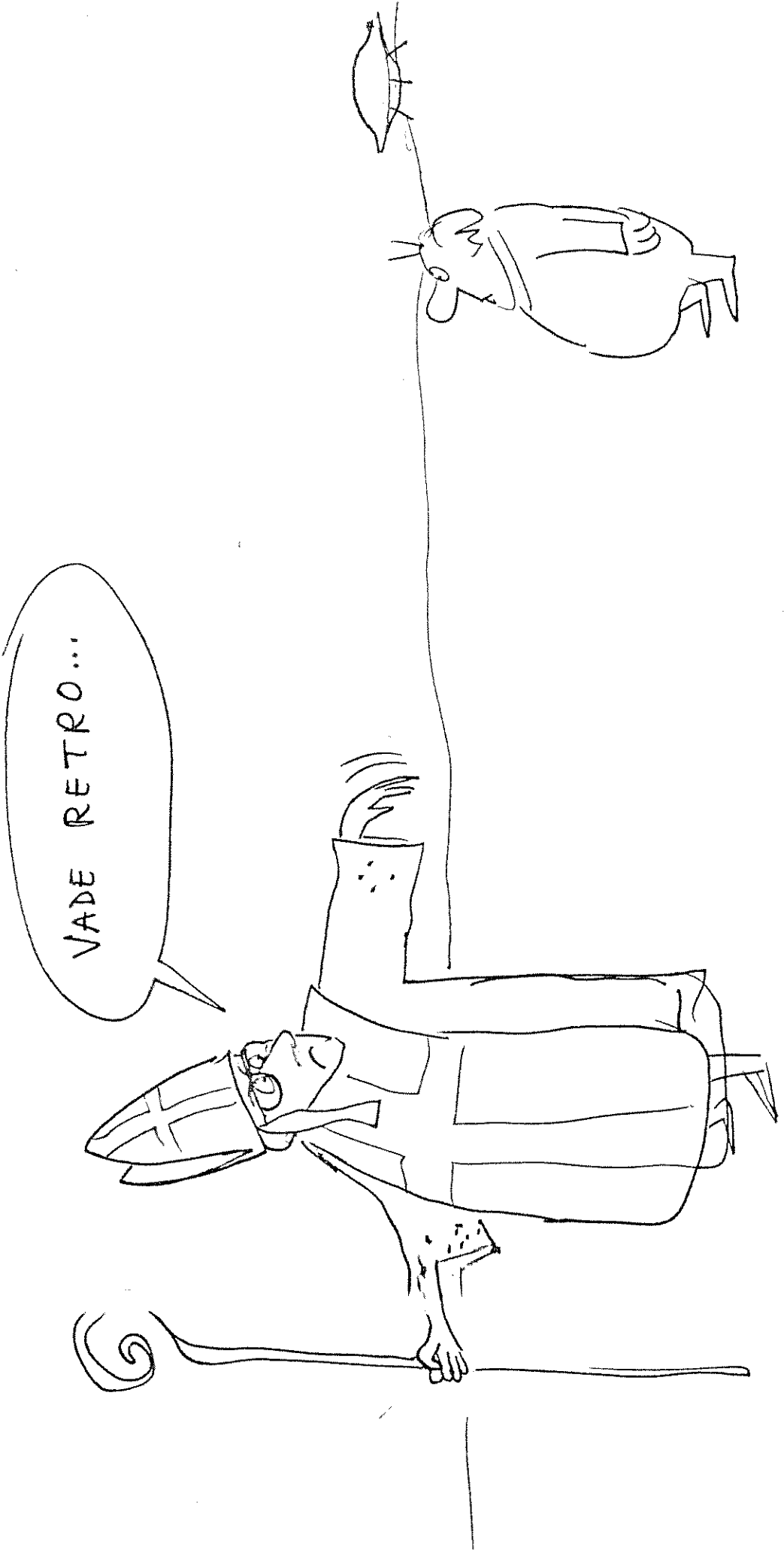

Jean Pina

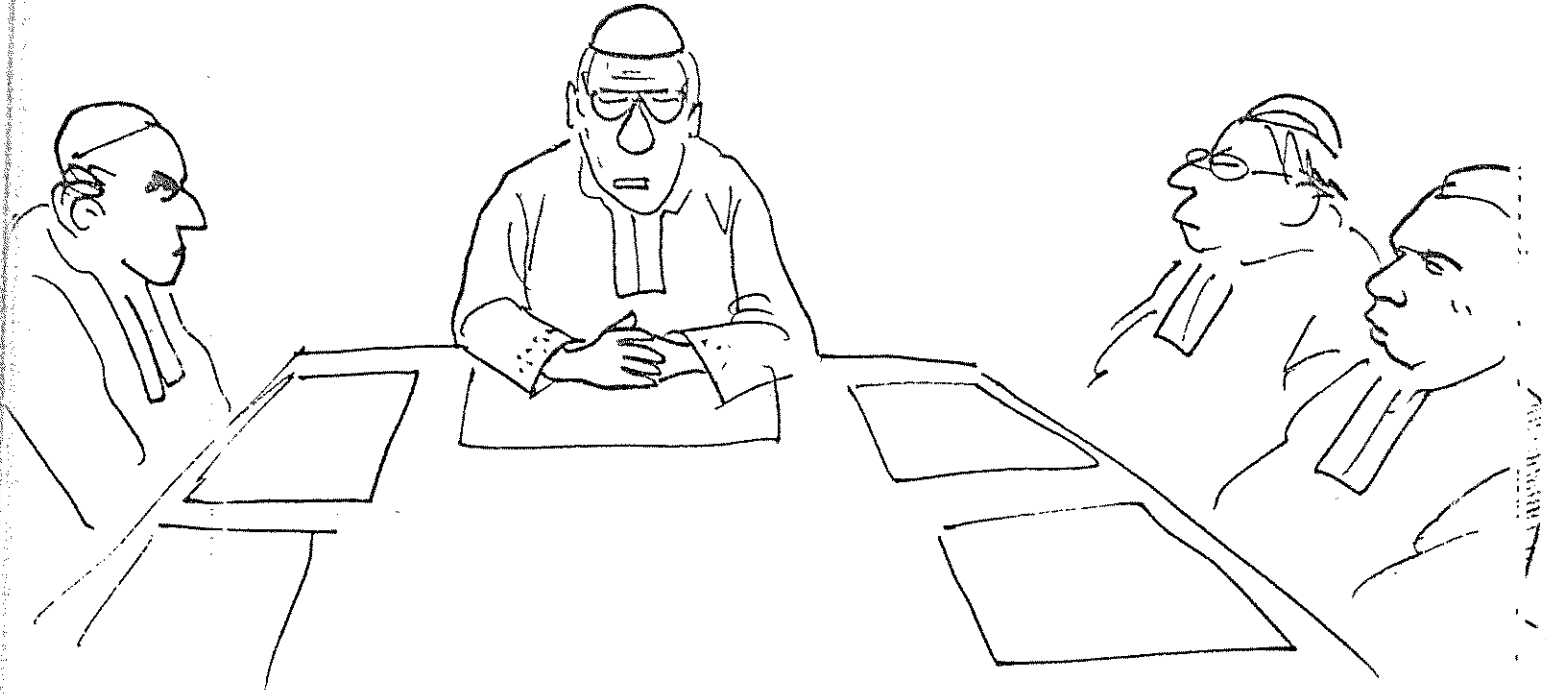
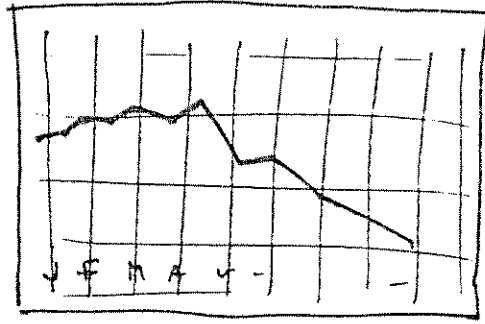



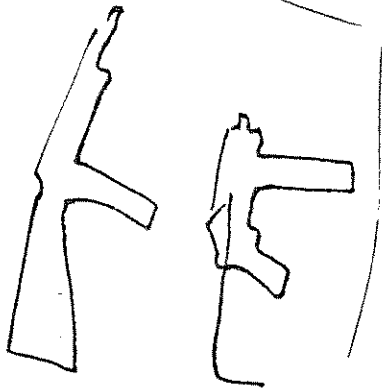

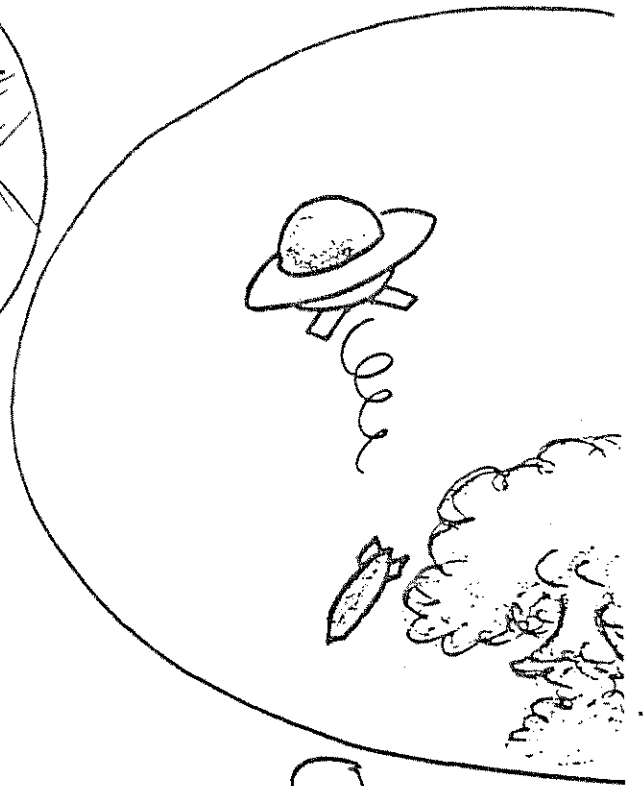
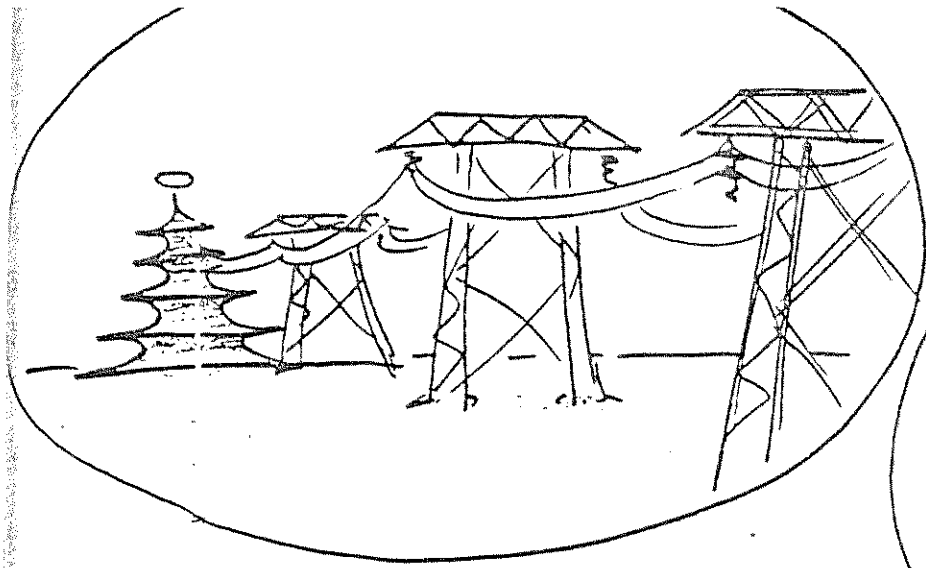

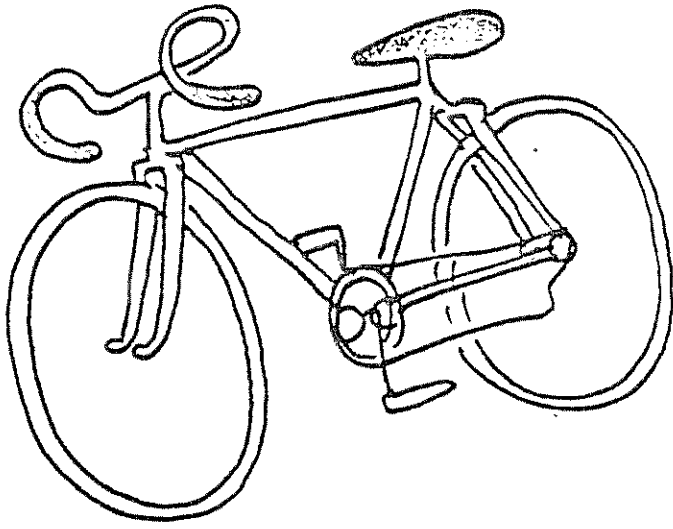

MUY BIEN, PERO  
¿ DE DONDE VIENE LA  
ENERGÍA ?



COMO SE  
PODA ESTO!!

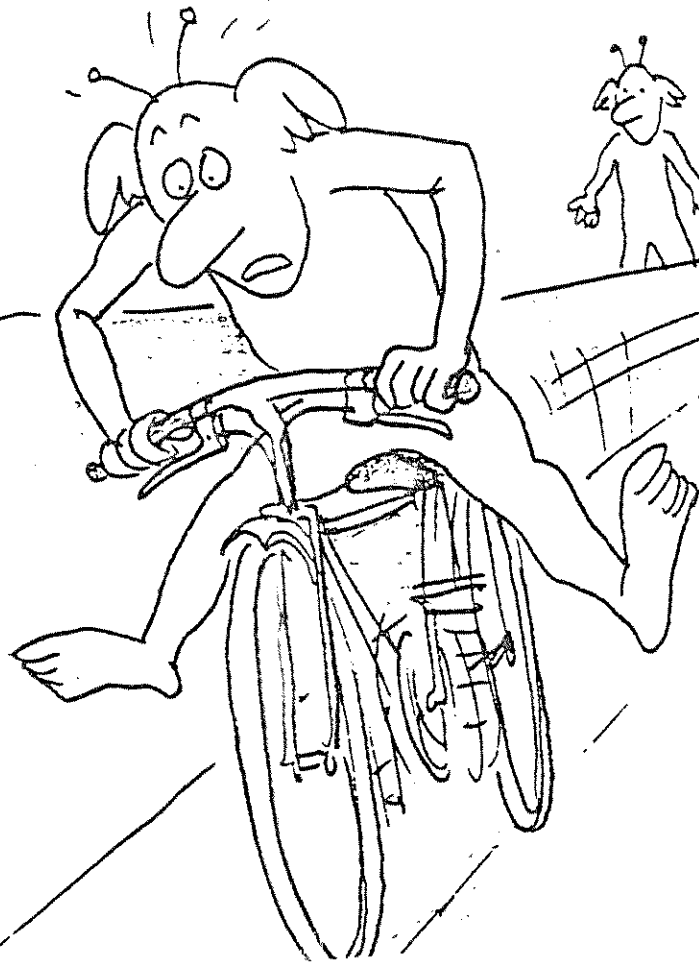

ME COMERIA MEJOR  
UN AUOWAINA



¿DE QUE UNIVERSIDAD  
ES USTED?



Jean Pierre Petit

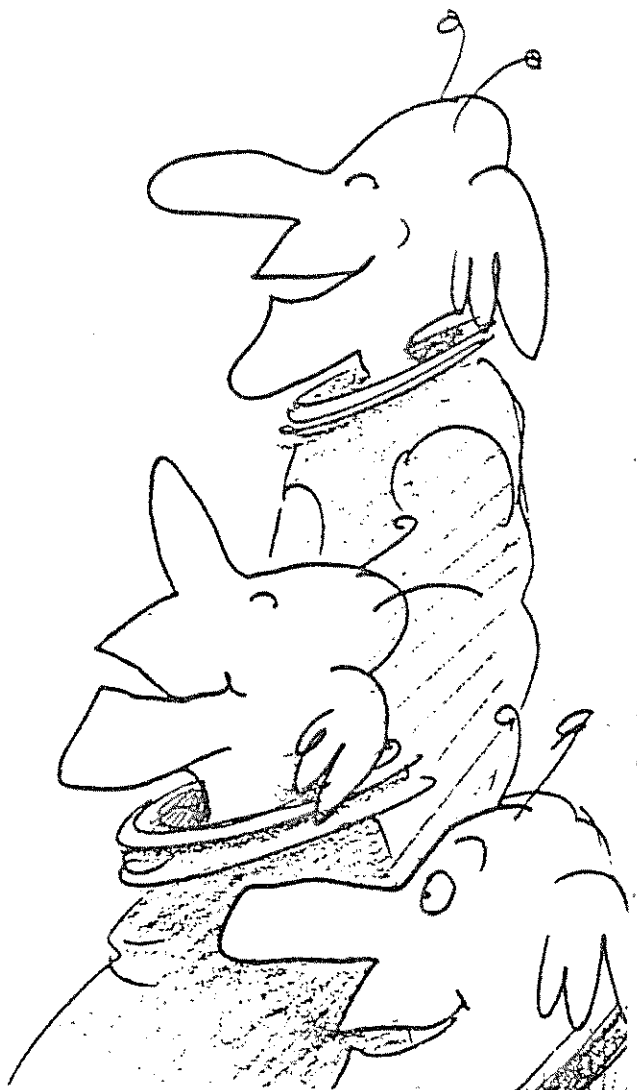
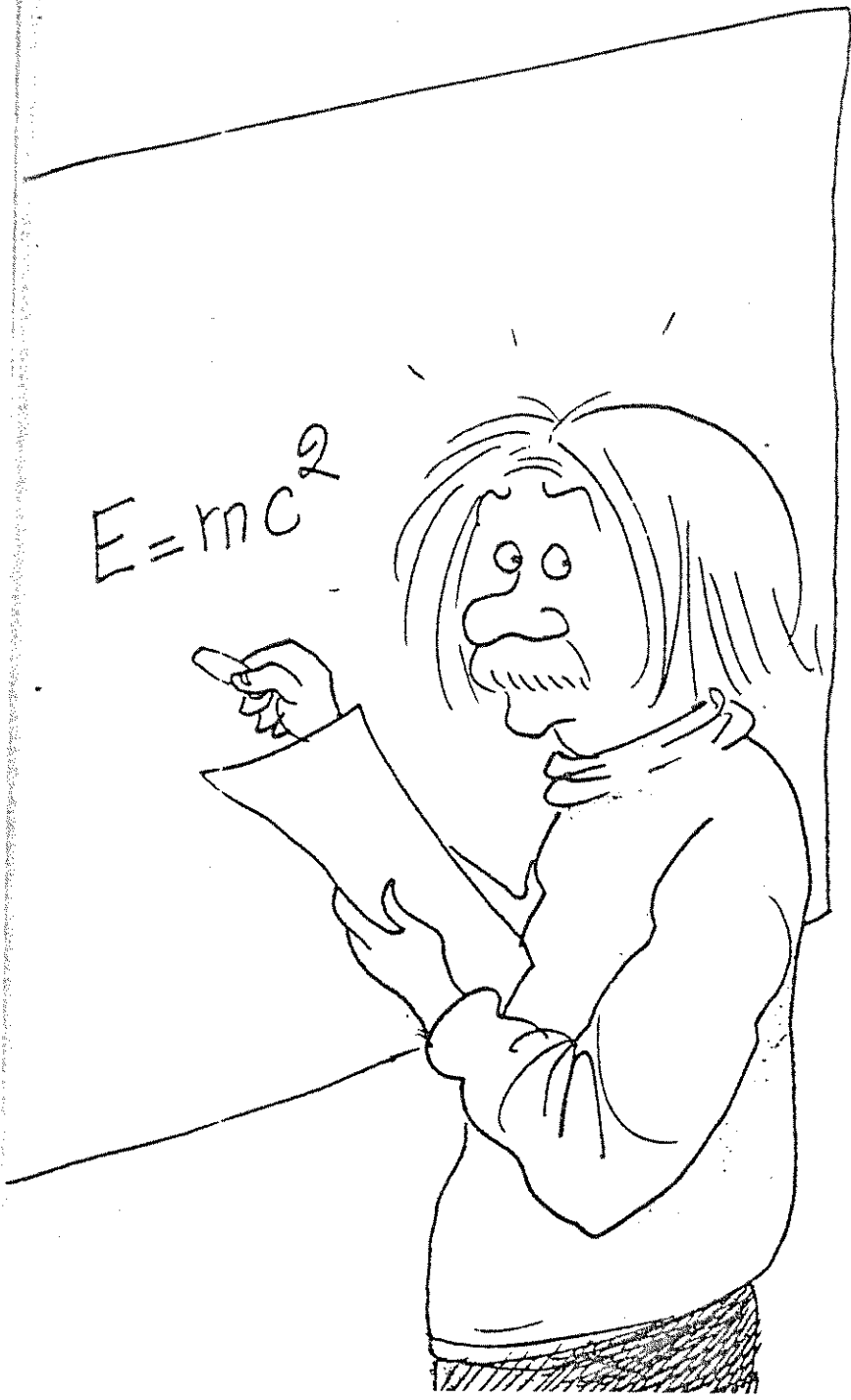

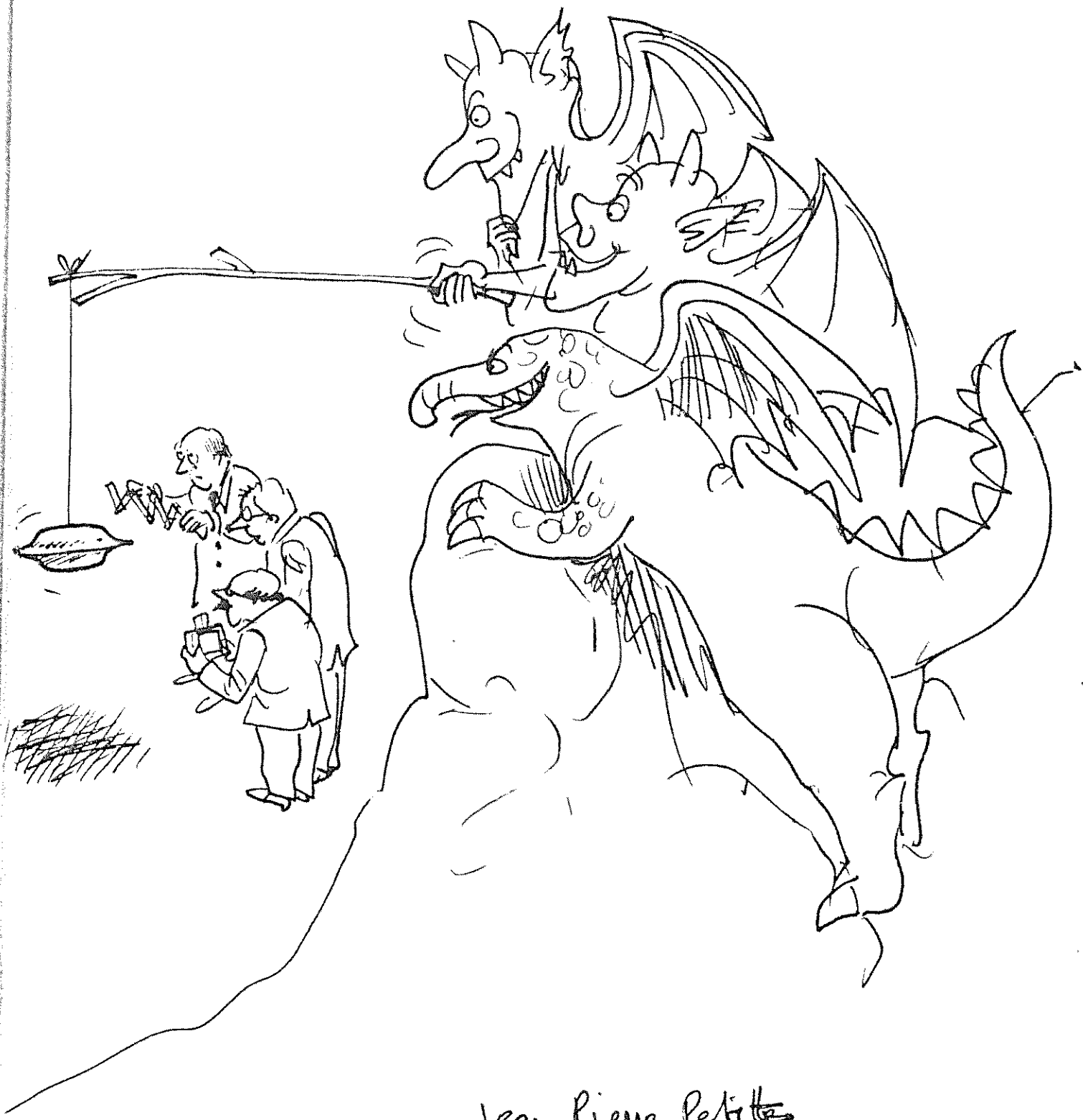

Jean Pierre Petitte  
1980



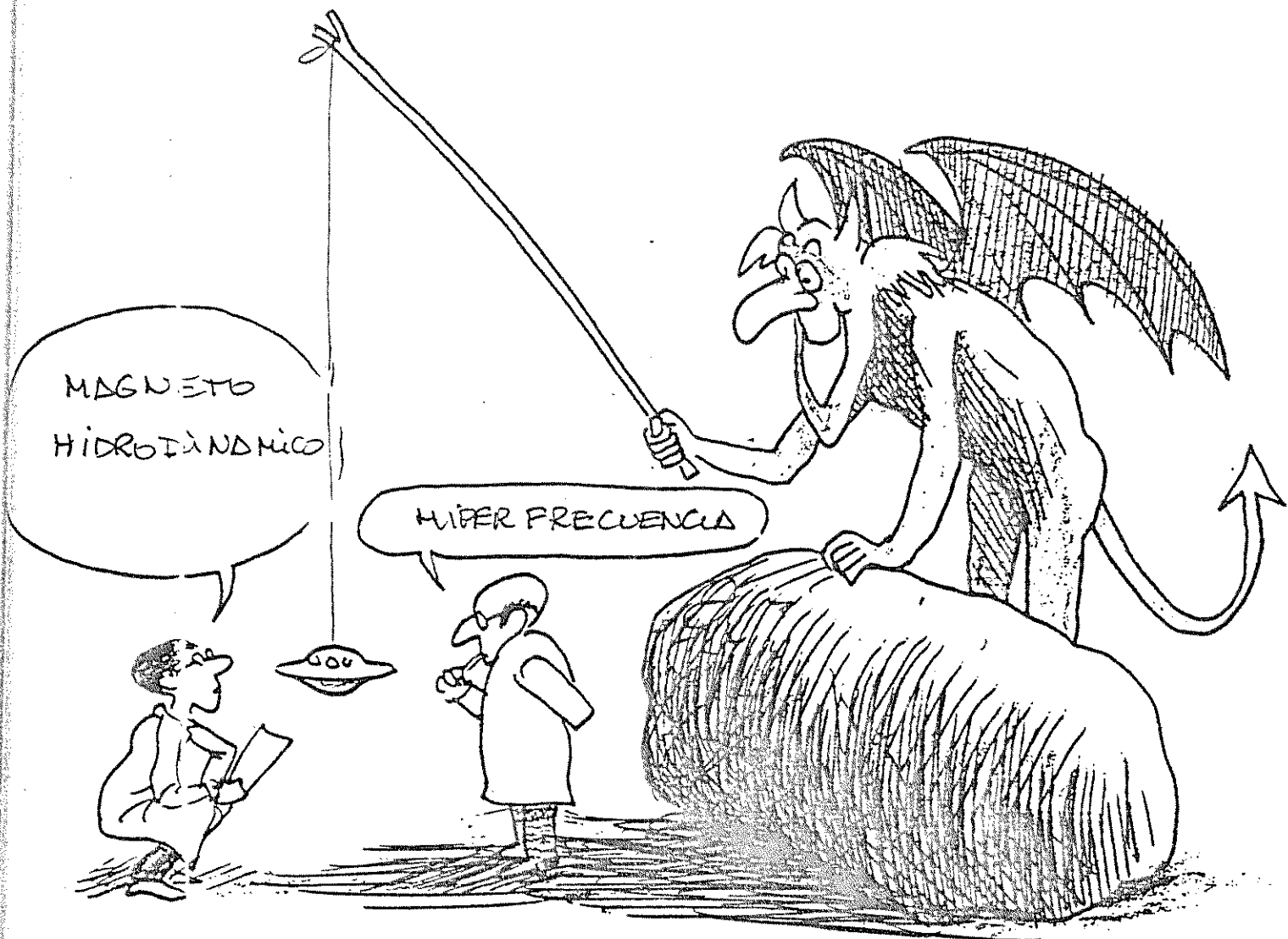

MAGNETO  
HIDRODINAMICO

HIPER FRECUENCIA

GOV

Hey, look, they are  
back, the frenchies  
on their flying M+D  
Camembert

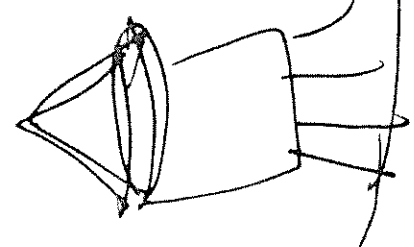
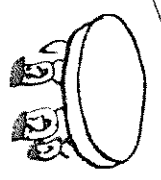

Jan 1. 1981

¿COMO HACEN  
PARA VOLAR RECTO?

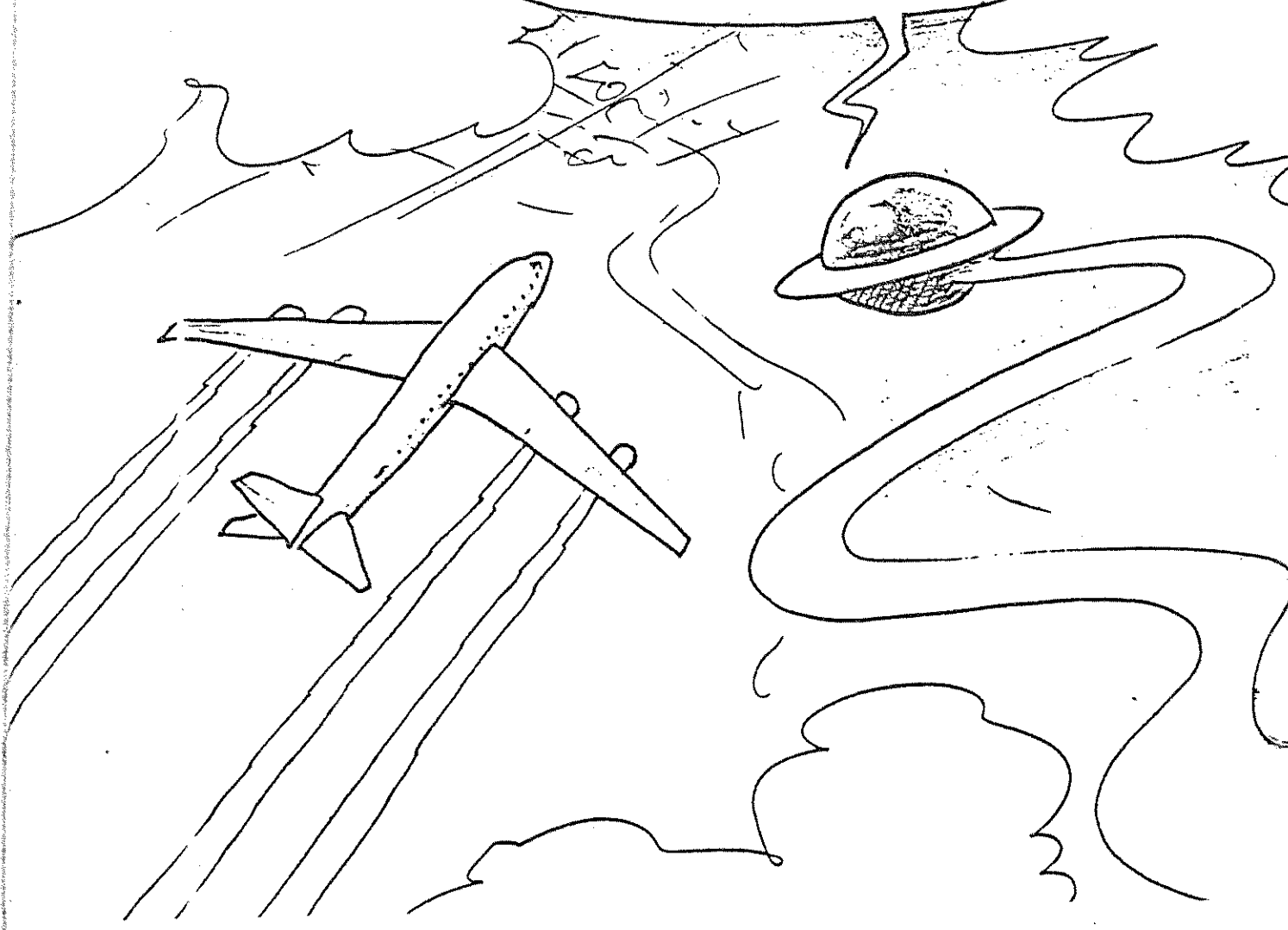

¿ NO COMPRENDO PORQUE  
VA HACER POLVO y HUMO  
A TAN ALTA ALTITUD ?

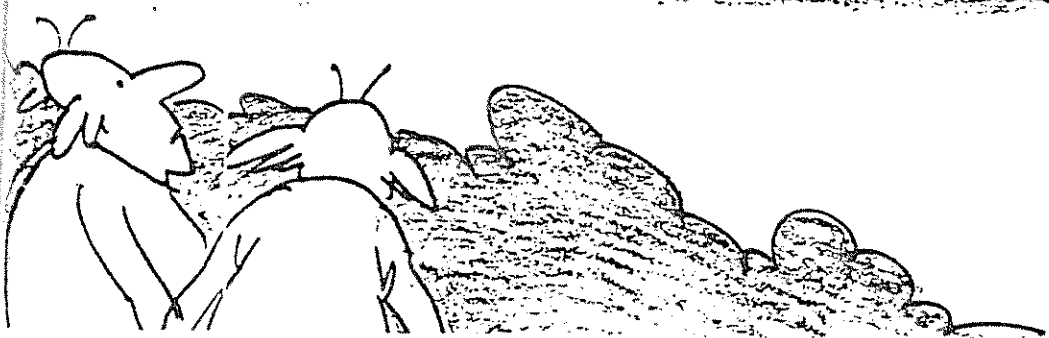
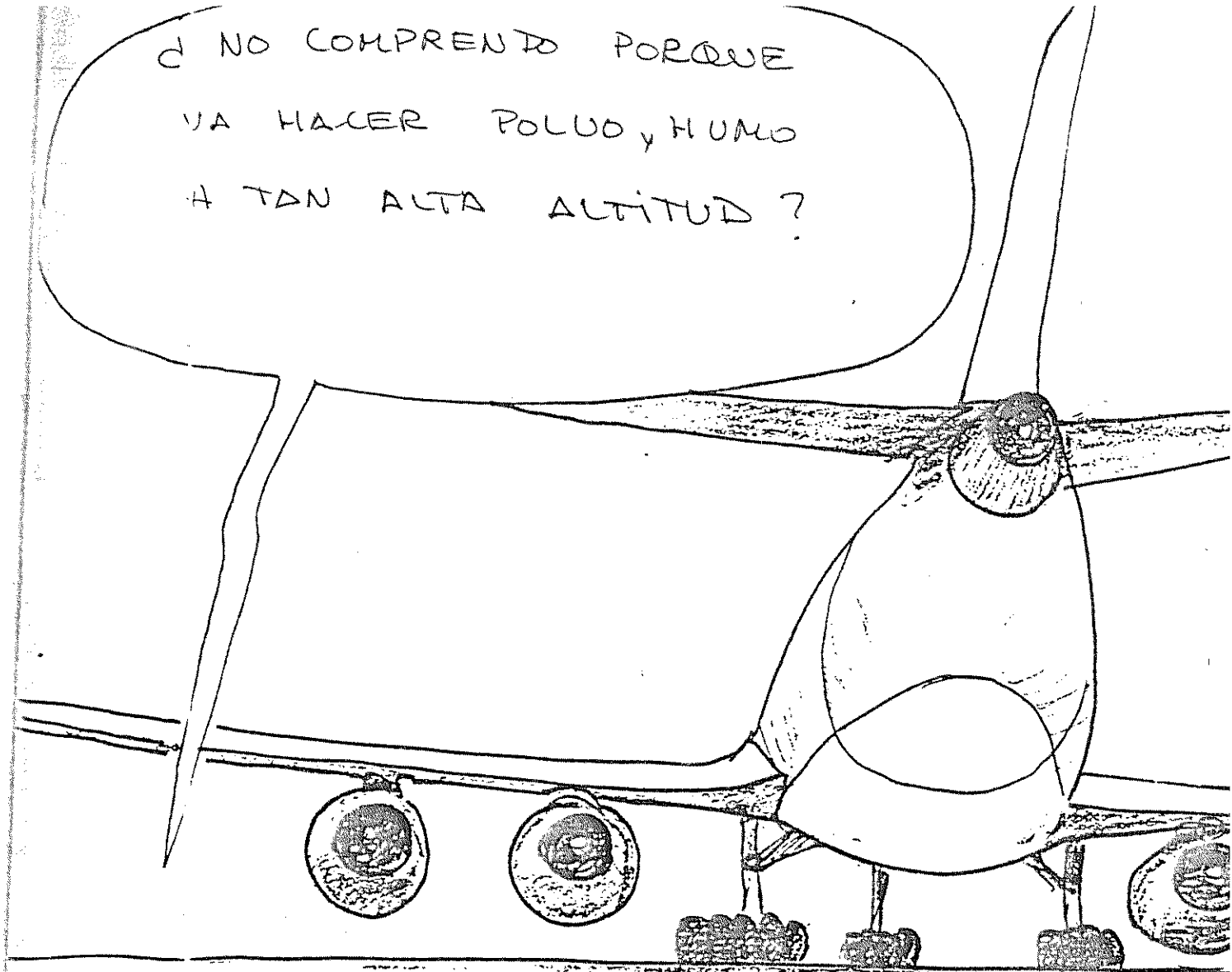

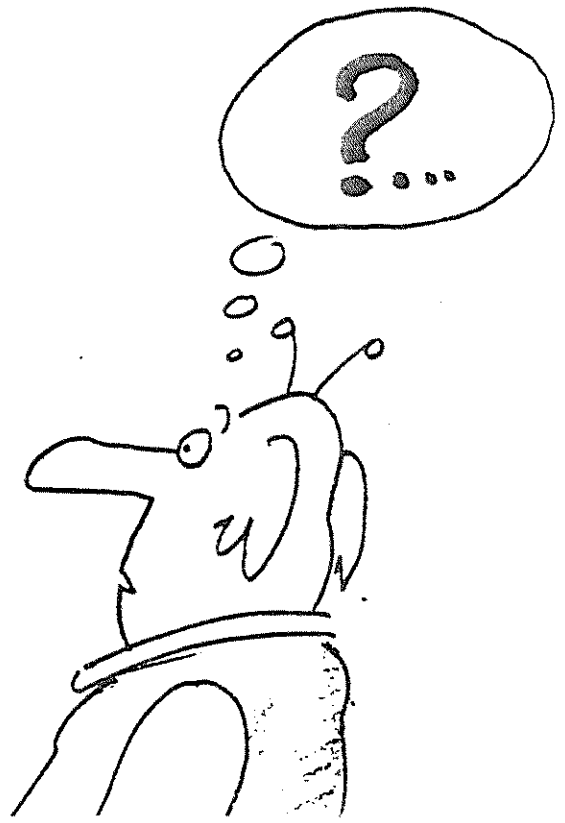
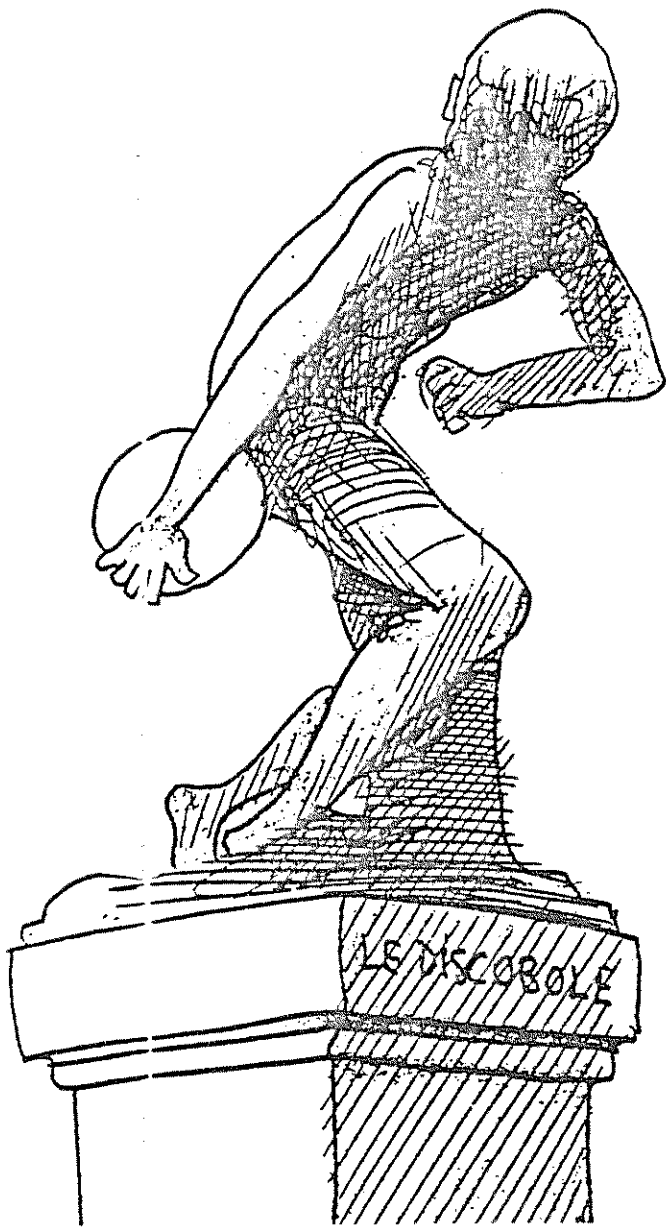

EL MENSAJE DICE QUE  
EL VEHICULO ESTABA  
APARCADO EN SENTIDO  
CONTRARIO Y NO TENIA  
PLACA DE MATRICULA



NO, NOSOTROS NO  
HEMOS VENIDO A  
VEROS NUNCA.





ES AQUI DONDE SE  
RECUPERAN LAS CENIZAS  
DE LA MAQUINA

EXTRAORDINARIO!



PUEDE QUE ESTO LE SIRVA  
EN LA TIERRA PARA BUSCAR  
SUS ALIMENTOS.

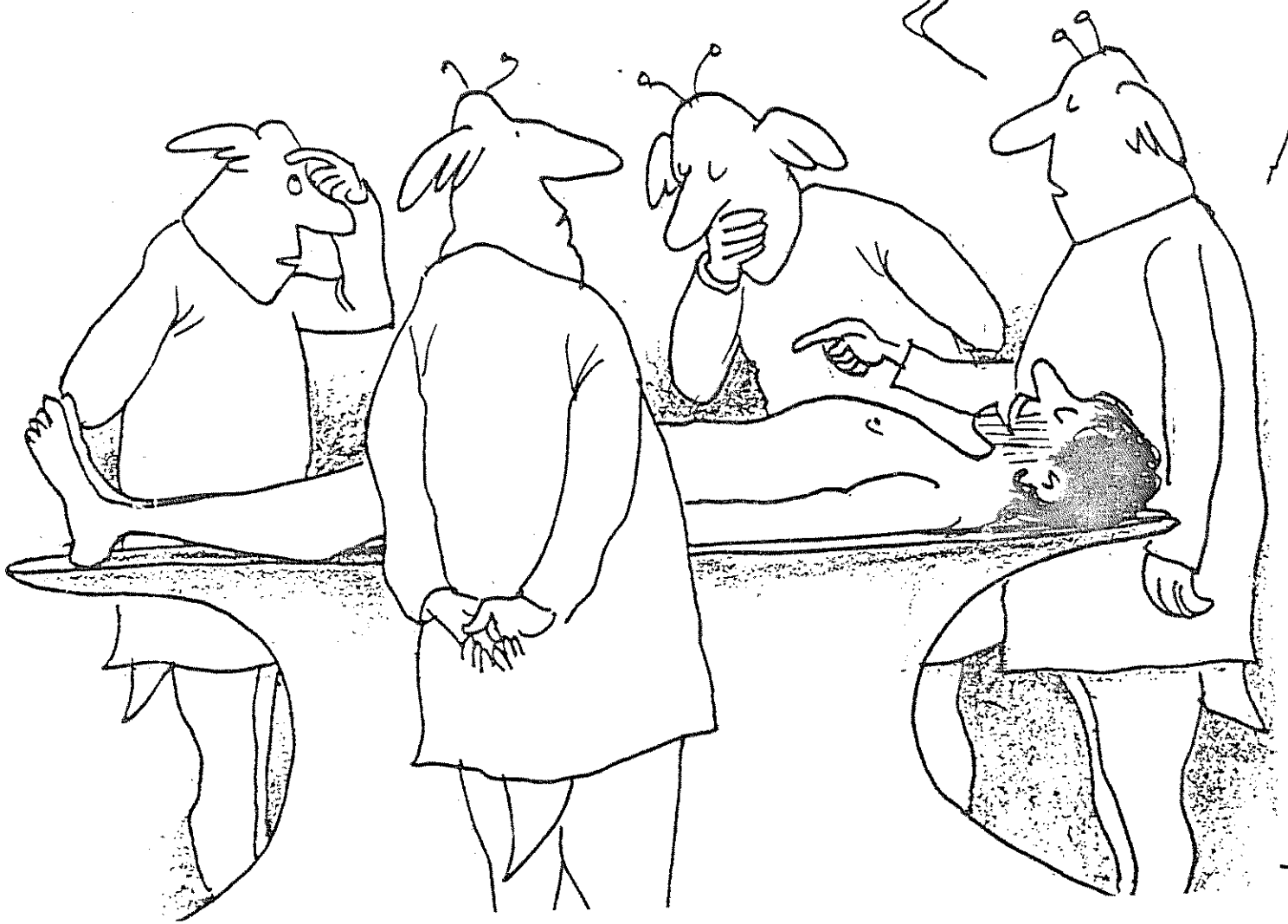

MI COMPAÑERO VA HACERLES LA  
DEMOSTRACION PORTATIL DE COMO  
HACEN PARA RESPIRAR .



SI NO ENCONTRAMOS  
NADA SERA MOLESTO.  
PERO SI ENCONTRAMOS ALGO  
AUN SERA MAS MOLESTO.



HEMOS VENIDO A VERLE  
PORQUE EN SUS LIBROS HAY  
DETALLES QUE NO SE PUEDEN  
INVENTAR ASI COMO ASI.



VAMOS A PONERLE EN ESTADO  
DE REGRESIÓN PSICOLÓGICA  
PARA HACERLE RECORDAR  
LO QUE HAY EN SU SUBCONSCIENTE .

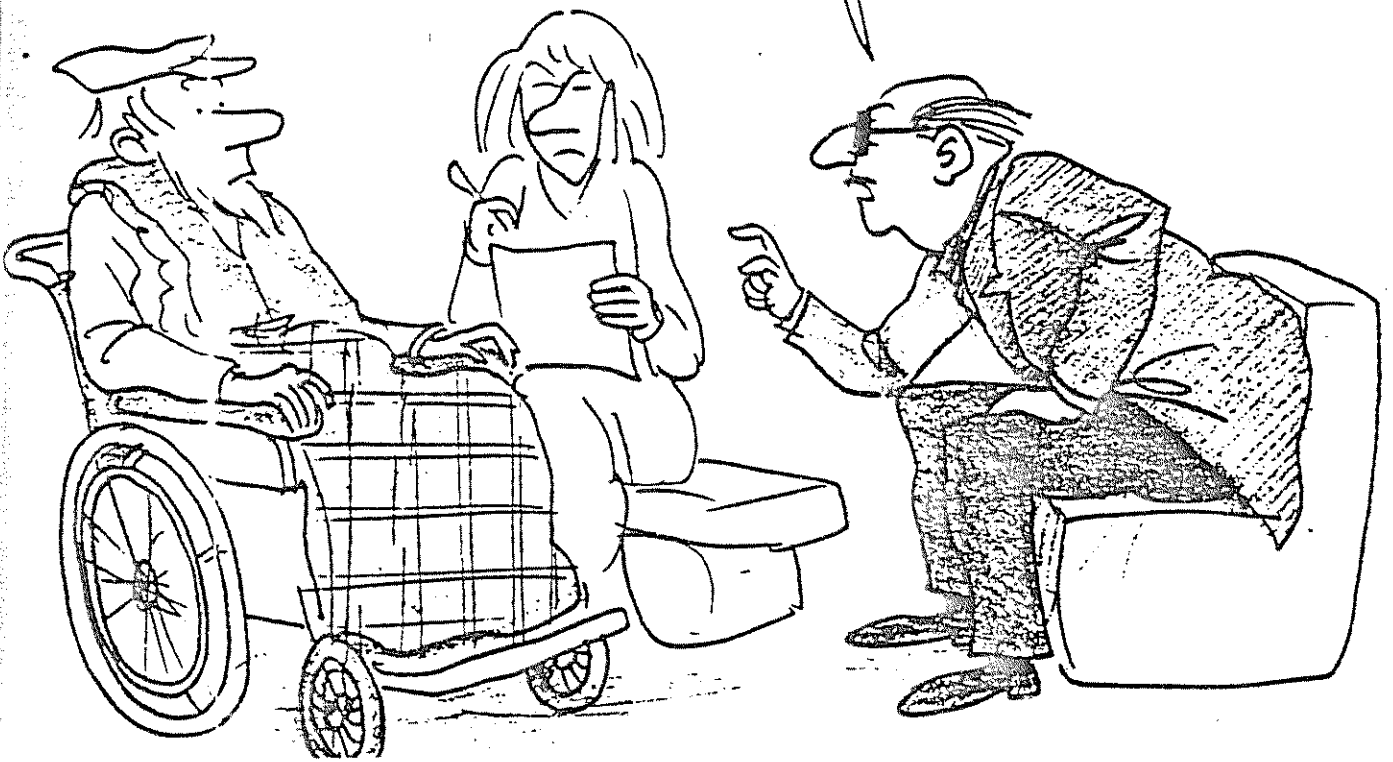

¿ES QUE USTEDES NO PODRIAN  
IMAGINAR ALGO MAS SENCILLO?



Pou Lou  
21 Nov 88

Jean Riviere

YO VENGO DE HABLAR  
CON LOS UMITAS



Pour Lou

LO VENGO DE HABLAR  
CON JEAN PIERRE PETIT



J. P. Petit

**SINDONE**

**20 Novembre 1988**



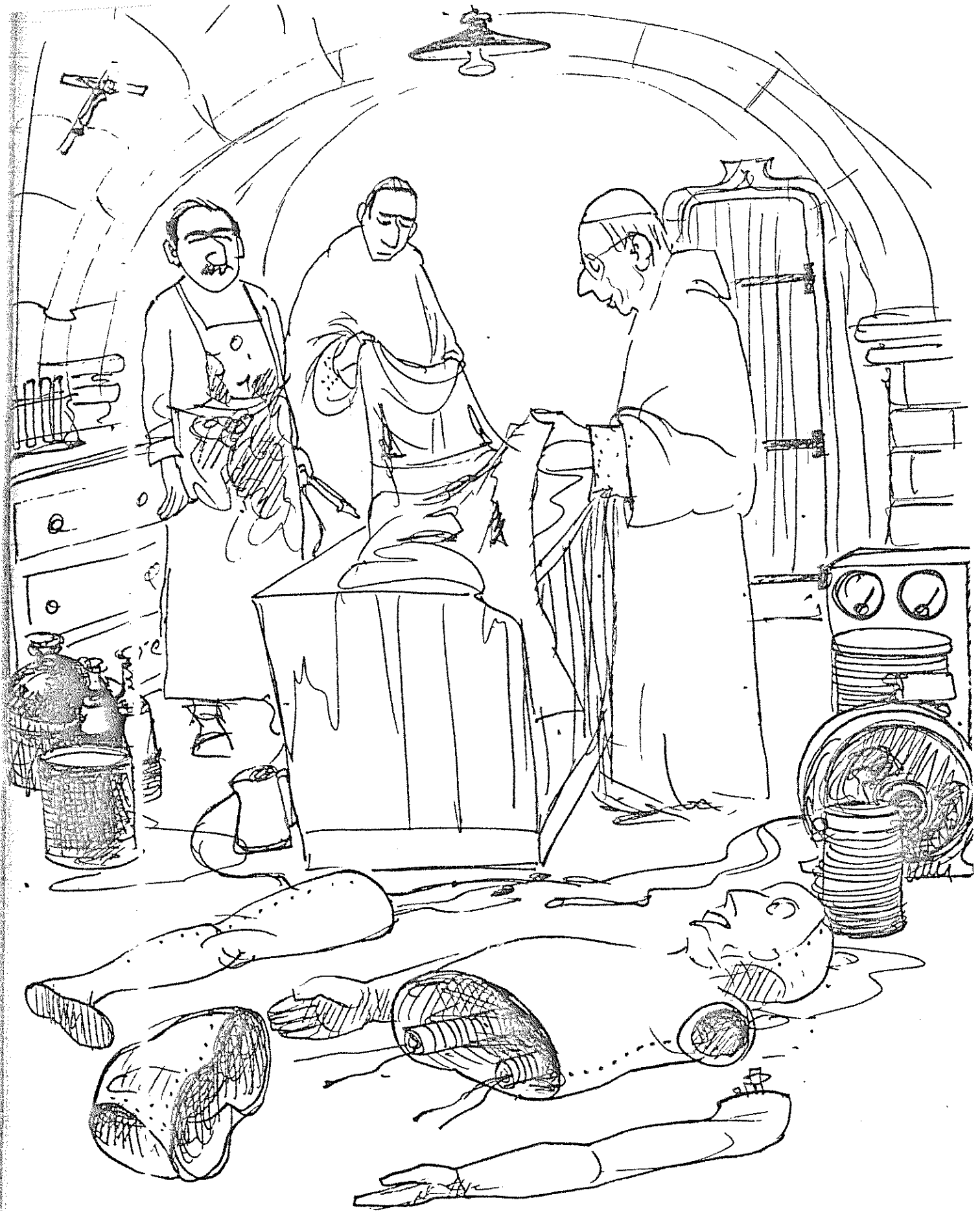



¡LO QUE FALTABA!



¿CÓMO SE  
DESARROLLA LA  
CHARLA ?



¡ PERFECTAMENTE !



21 Nov 88

Jean Pierre Petit

Si quieres mi opinión,  
hay que volver al hotel corriendo....



Kan Pilsue  
Pehat

¿KGB?

NO, MOSSAD...



CONGRESO CIENTIFICO SOBRE  
LA VIDA EXTRATERRESTRE

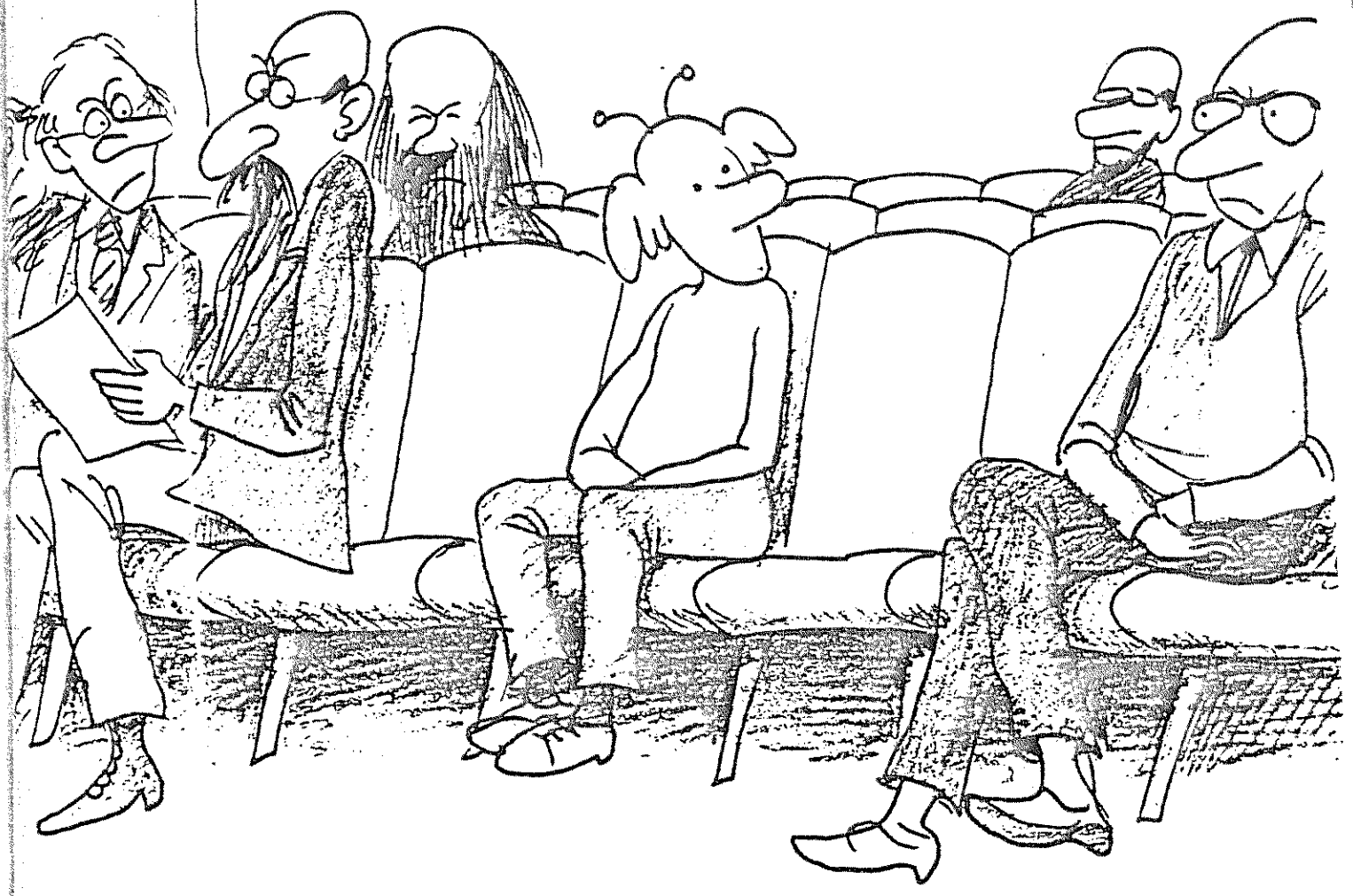



# HUMOR EN 'EL BOSQUE'

(FINCA DE RAFAEL FARRIOLS CALVO  
ARGENTONA (BARCELONA))

BASTANTE JUEGO  
LLEVA ME A CASA



kanli ene letet

¿ QUE QUIEREN DECIR  
POR RELATIVIDAD  
RESTRINGIDA ?

SABES, ESTOY  
UN POCO CANSADO - - -

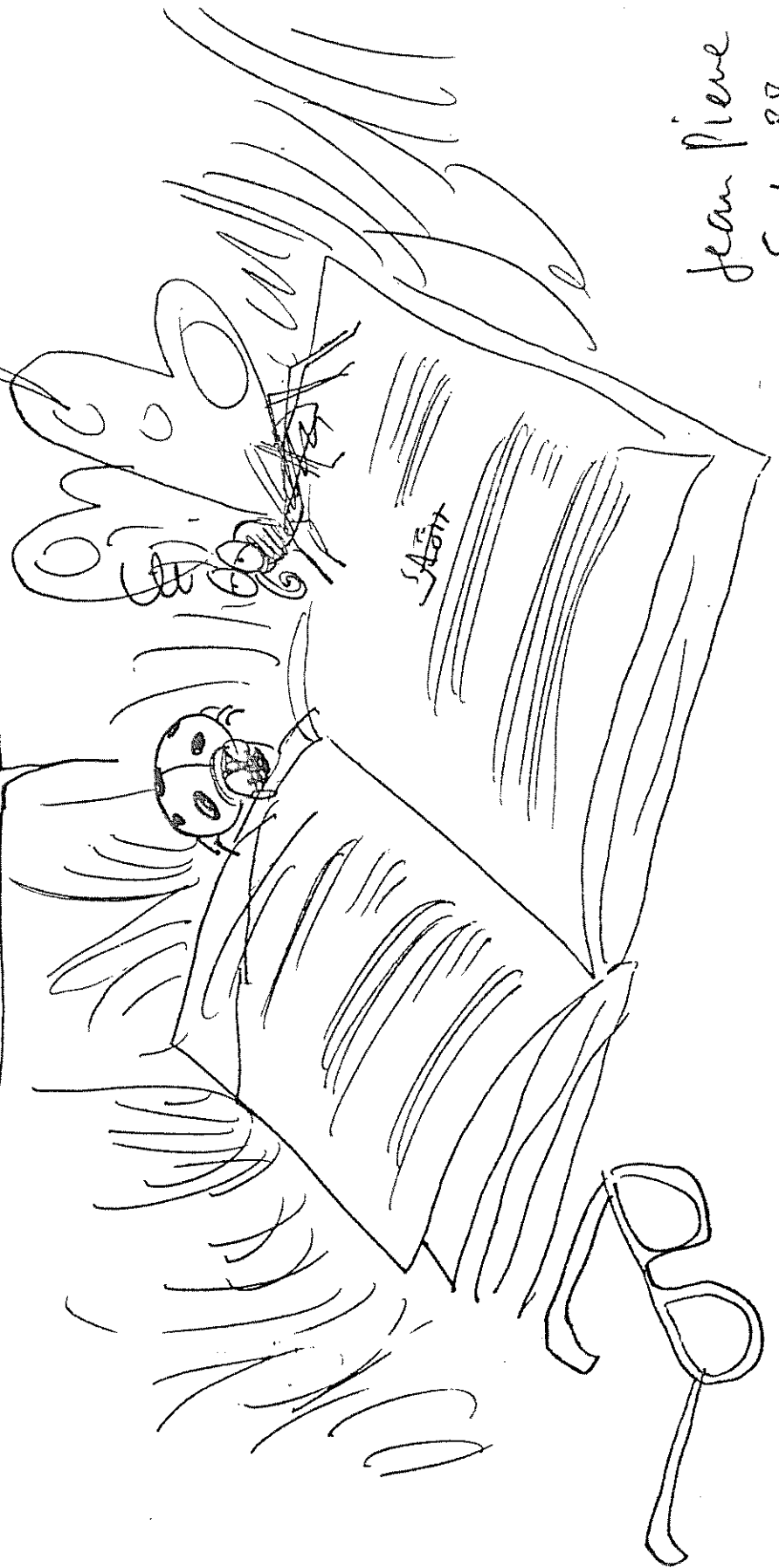

Jean Pierre  
Sept 88

ES UN MODELO DE OCCASION  
PERO NO SABEMOS COMO CONducIRLO



from Pierre Petit  
Scott PP

ESPERO QUE UN DÍA  
COMPRENDEREMOS SU  
LENGUAJE.

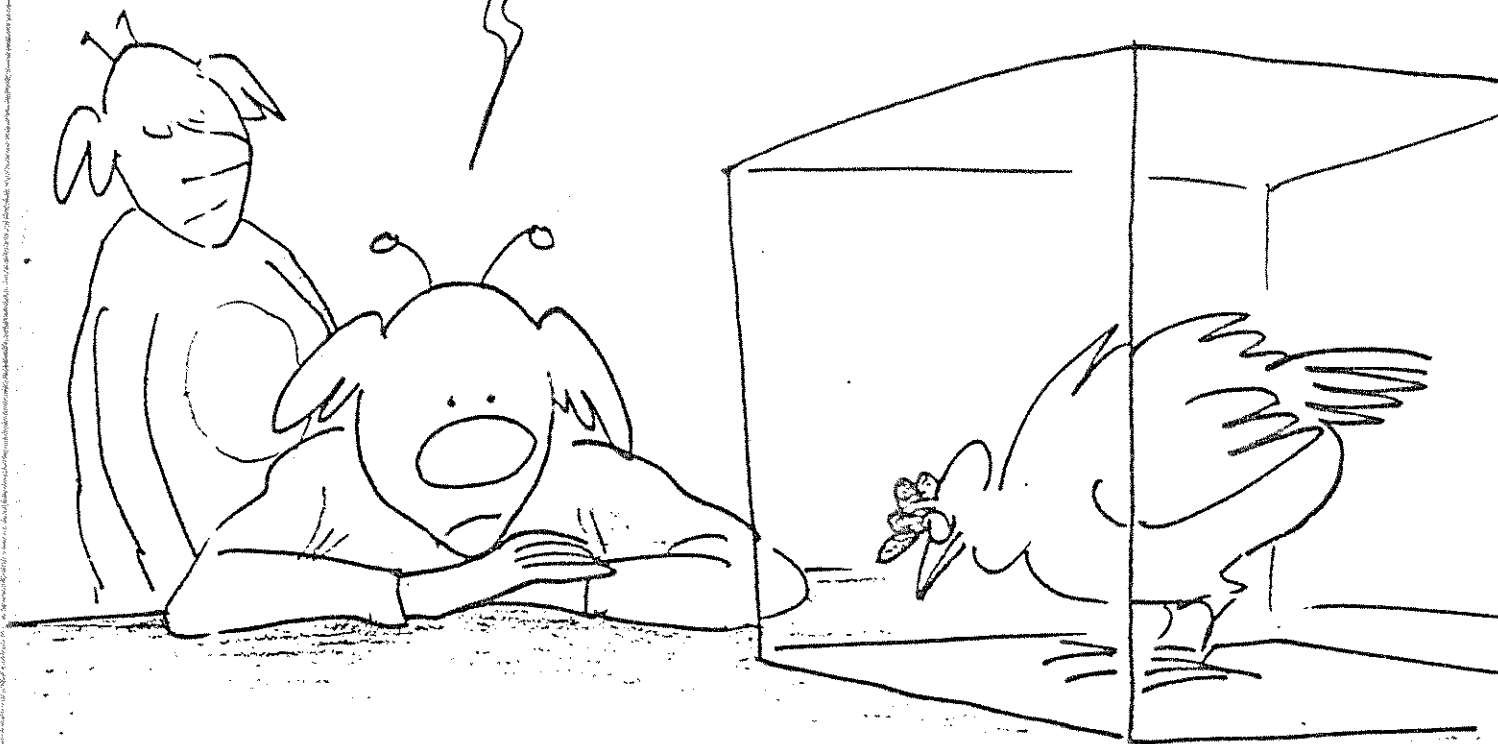

¿PERO QUE QUIERE DECIR  
EXACTAMENTE POR HYPERESPACIO ?



Jean Piene Petet  
Sept 88



Jean Pierre Petit  
Sept 88

Son Los Animales quienes "informan"?

HÉ HECHO UN PROGRAMA DE  
GRATIA JOR PARA CONTROLAR  
LAS ACTIVIDADES DE RAFAEL



Jean Pico



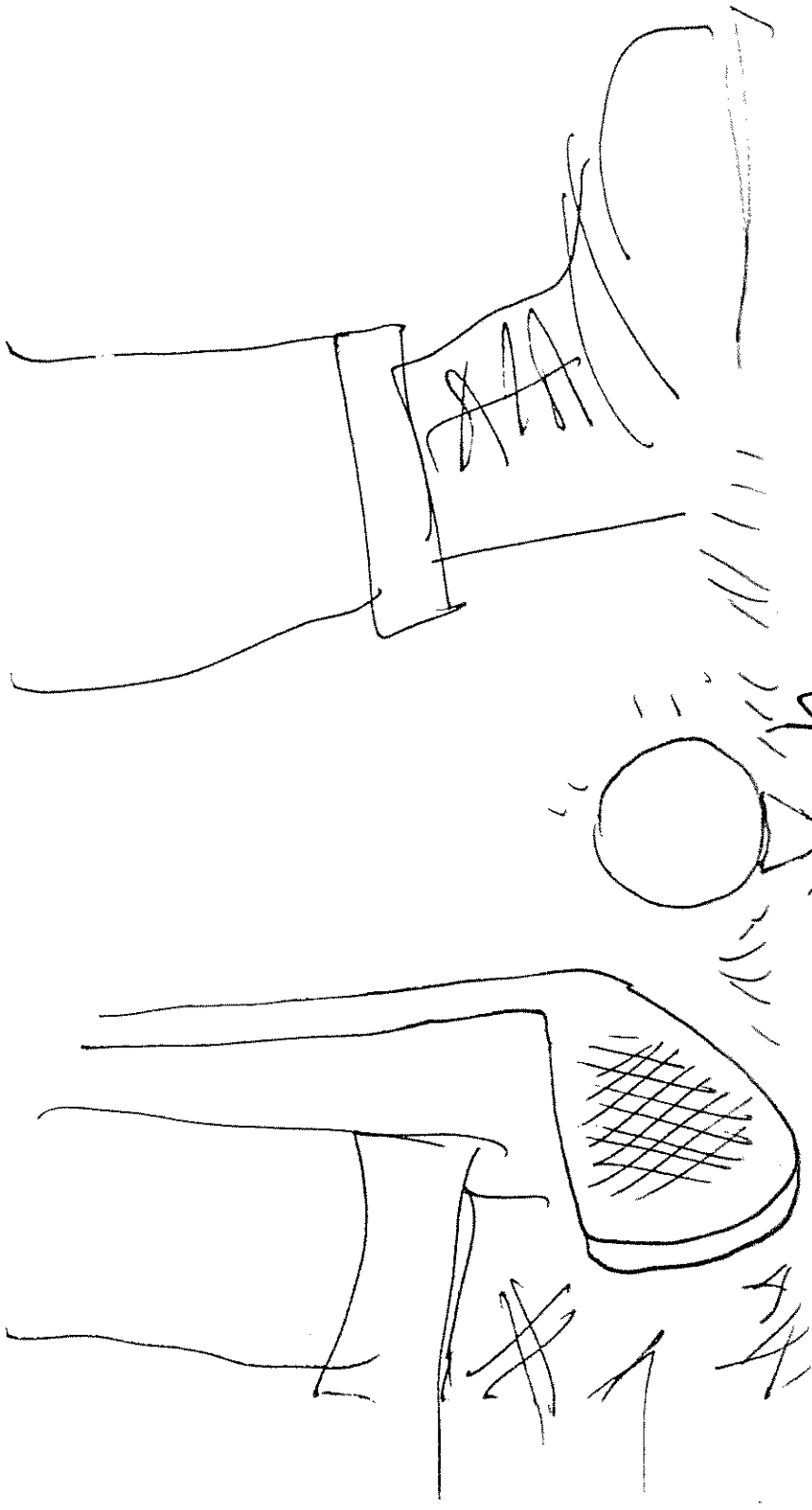

Jean Pierre

de collé, vite!!!

deceps, rapido!

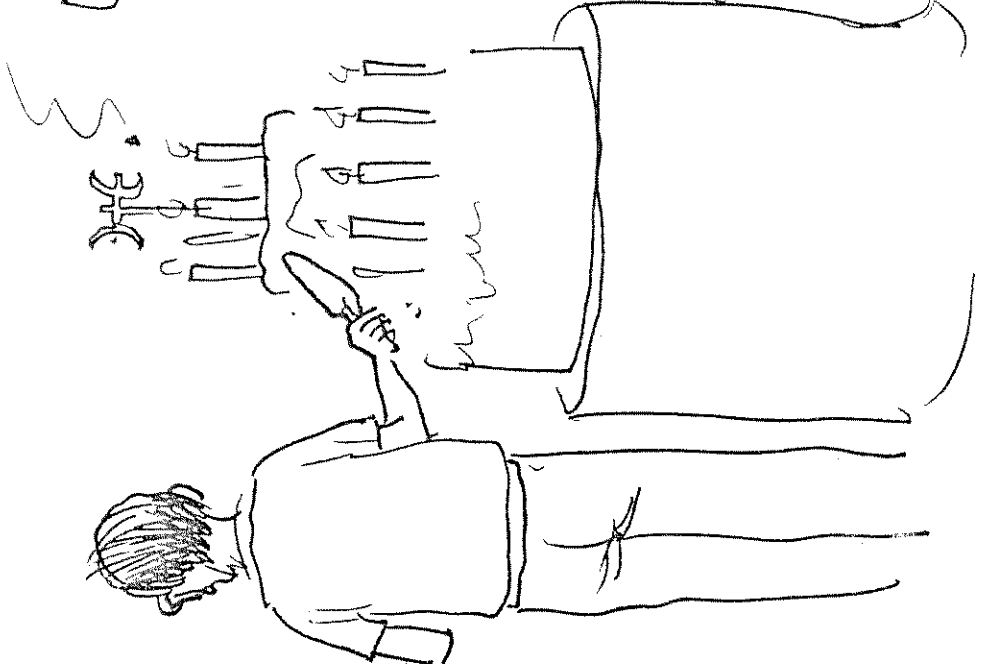
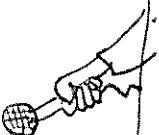

27 Sept 1988

Jean Pierre Petit

Los Ummitas (escuadros) !  
¡ Ostad! Carmela los estropeado  
i el ultimo a parsto que nos  
quedaba!



Jean Pierre Lehot

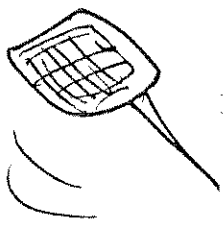
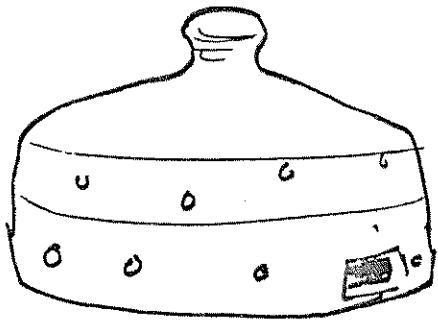

DE PRISA, DE PRISA  
QUE VIENE CARRELA -----

Jean Pierre

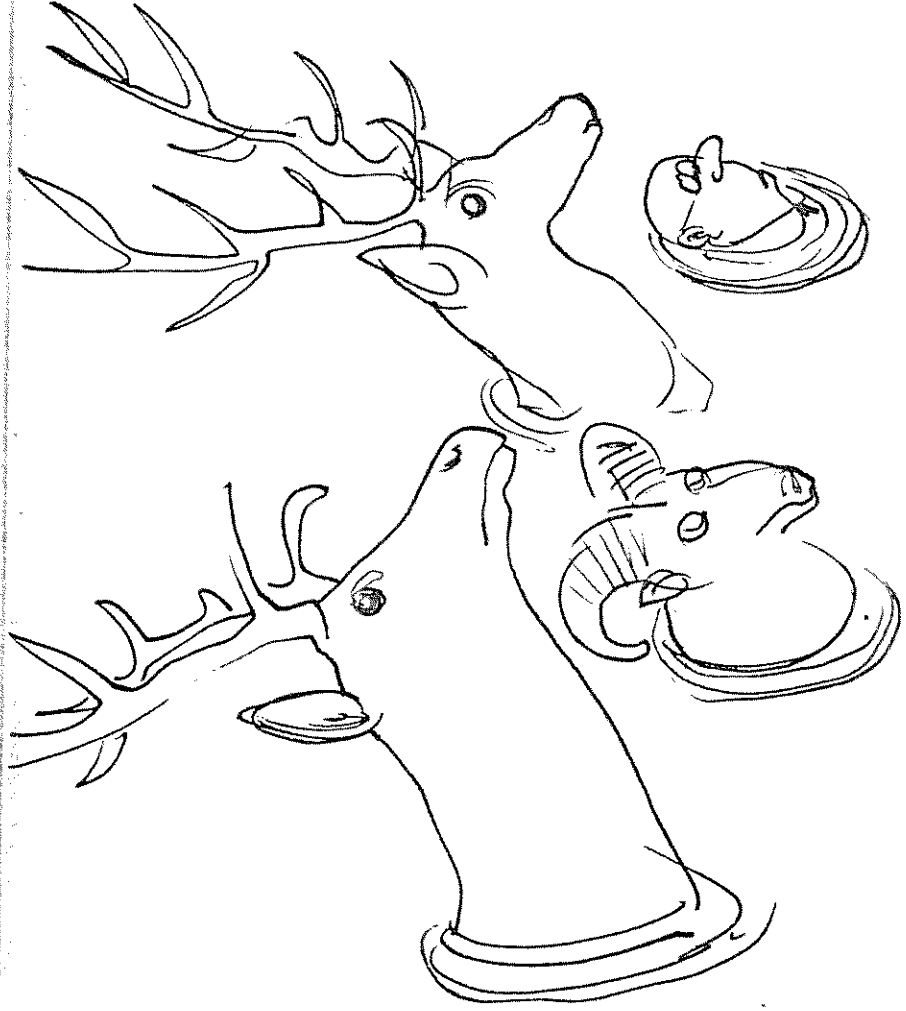

ES EL HOMME QUÉ HA HECHO  
EL FRAUDE DE MESAJE  
DE RECEPCIÓN EN 21 cm<sup>2</sup>.



Jean Pierre Petot  
Sept 88

Septembre 1988

KGB ?



NON, MOSSAD  
et vous ?

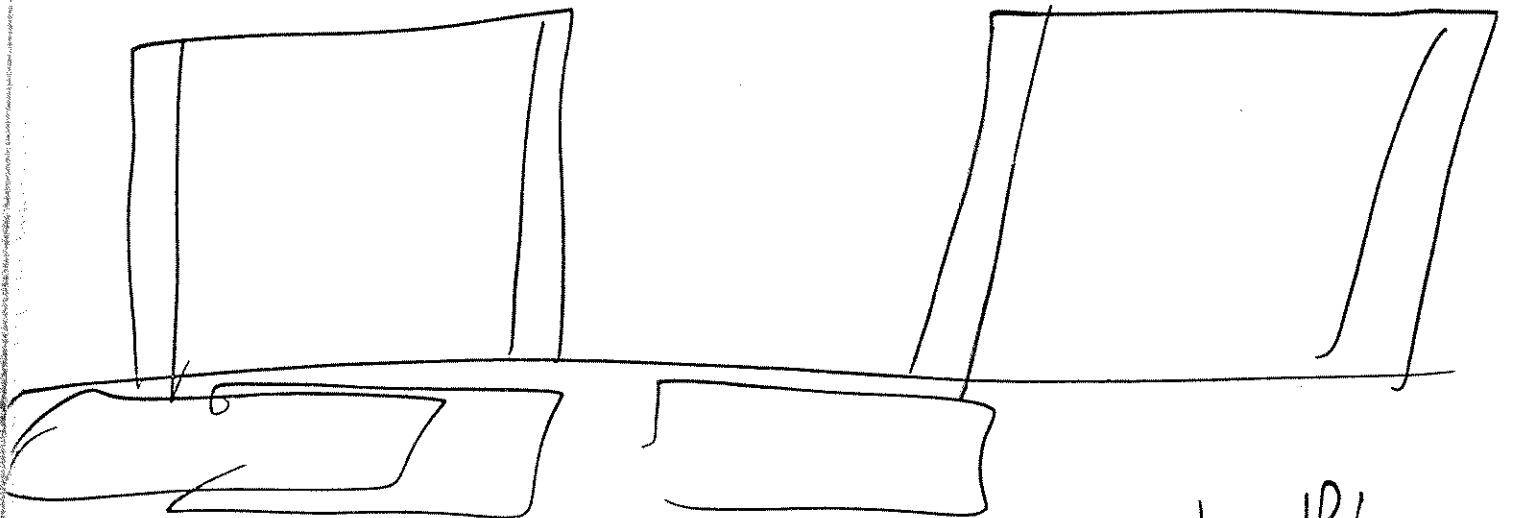

Achévé d'imprimer  
par Casterman, s.a., Belgique.  
N° d'éditeur : 4900.  
Dépôt légal : Février 1985.

Jean Pierre  
Relet

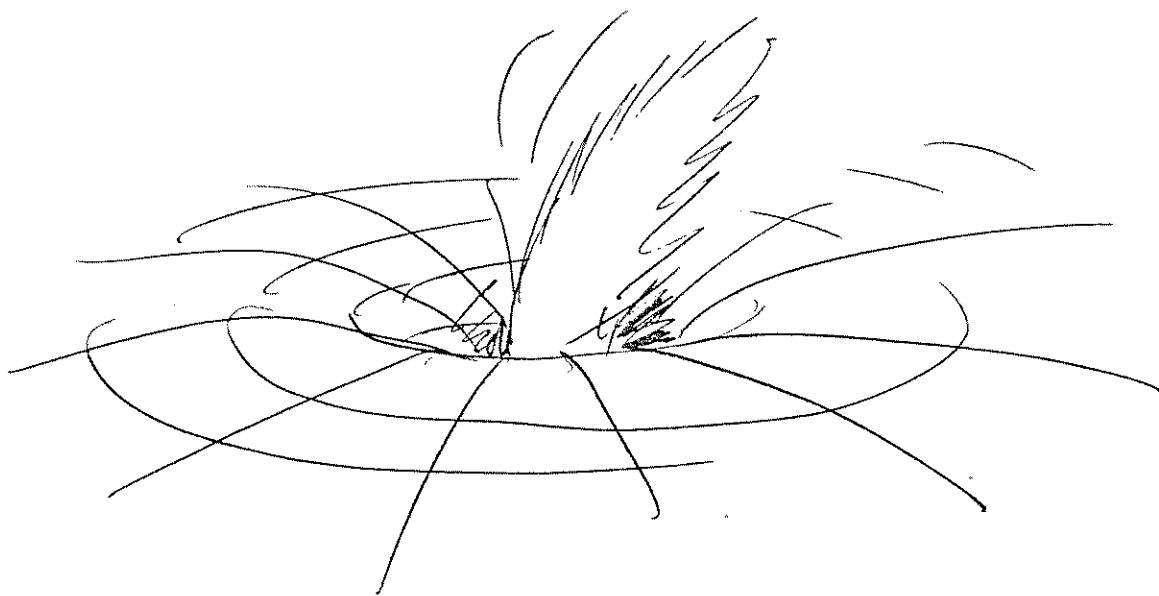
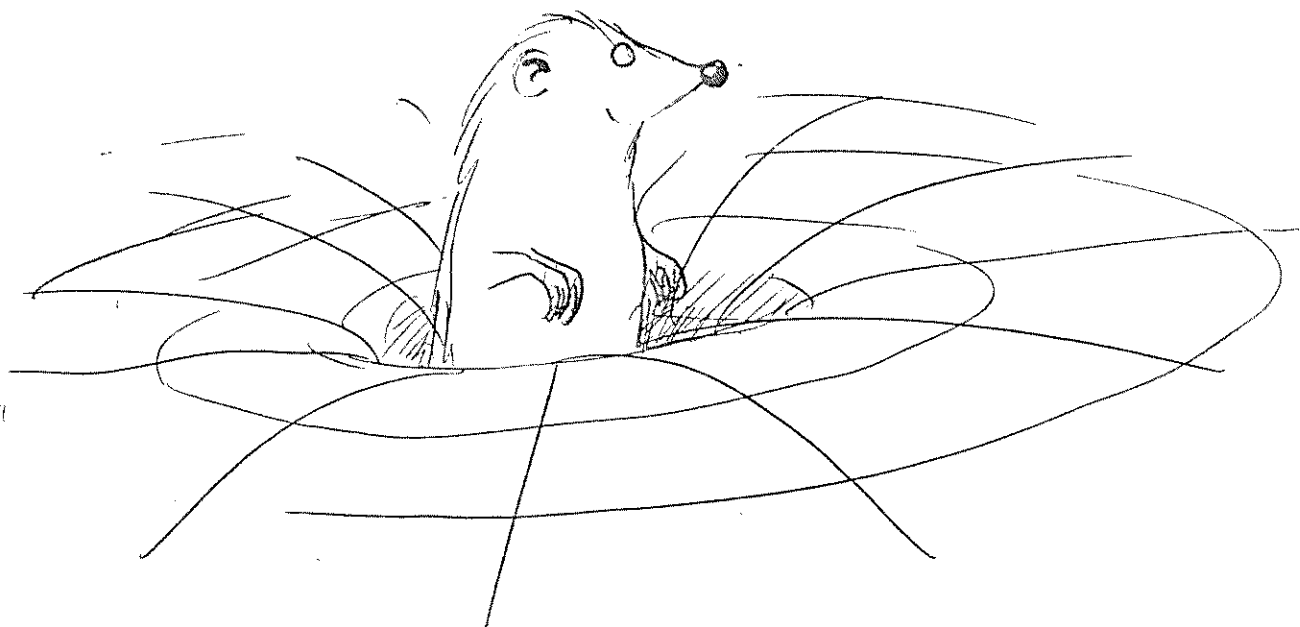



17 1 00



TENEMOS OTRO MODELO EN VERDE

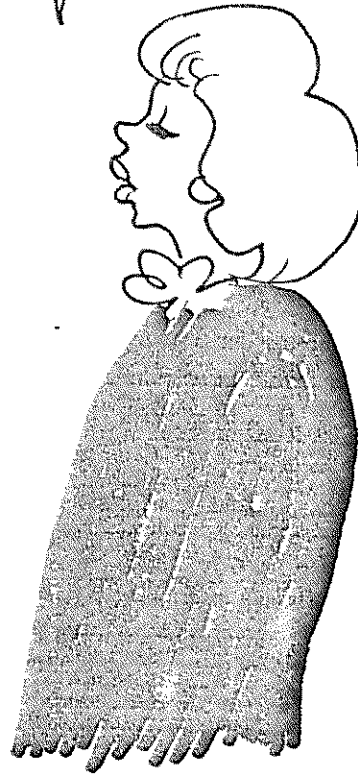

BUENO VOY A TOMAR ESTE

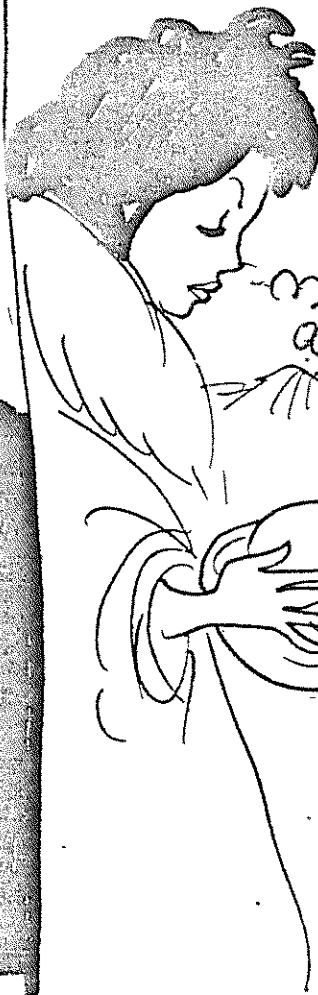
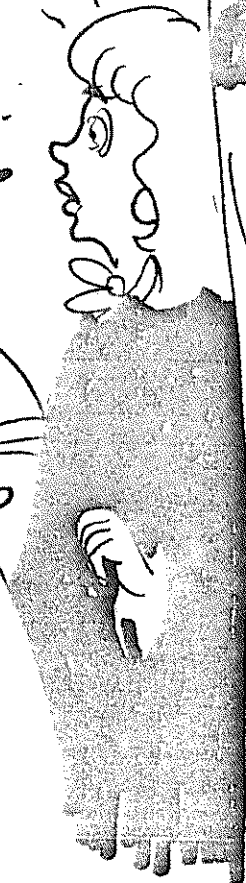

?!



JUSTIA!

QUASI!



# PARANORMAL

13-1-80

VAMOS AHORA CONTESTAR A  
VUESTRAS PREGUNTAS SOBRE  
EL PARANORMAL



PARA DE HACER  
EL TONTO !!

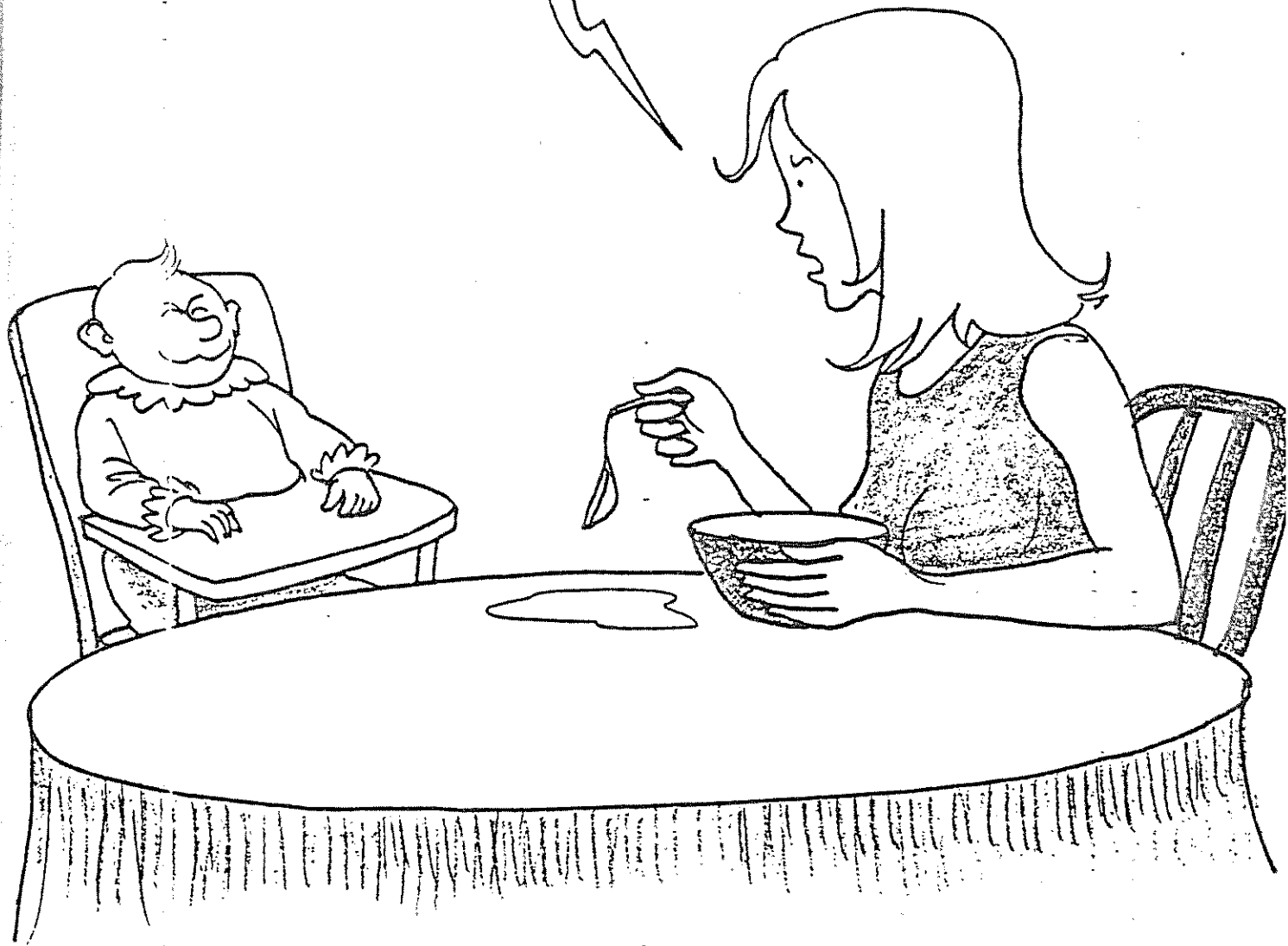

Janvier 1990

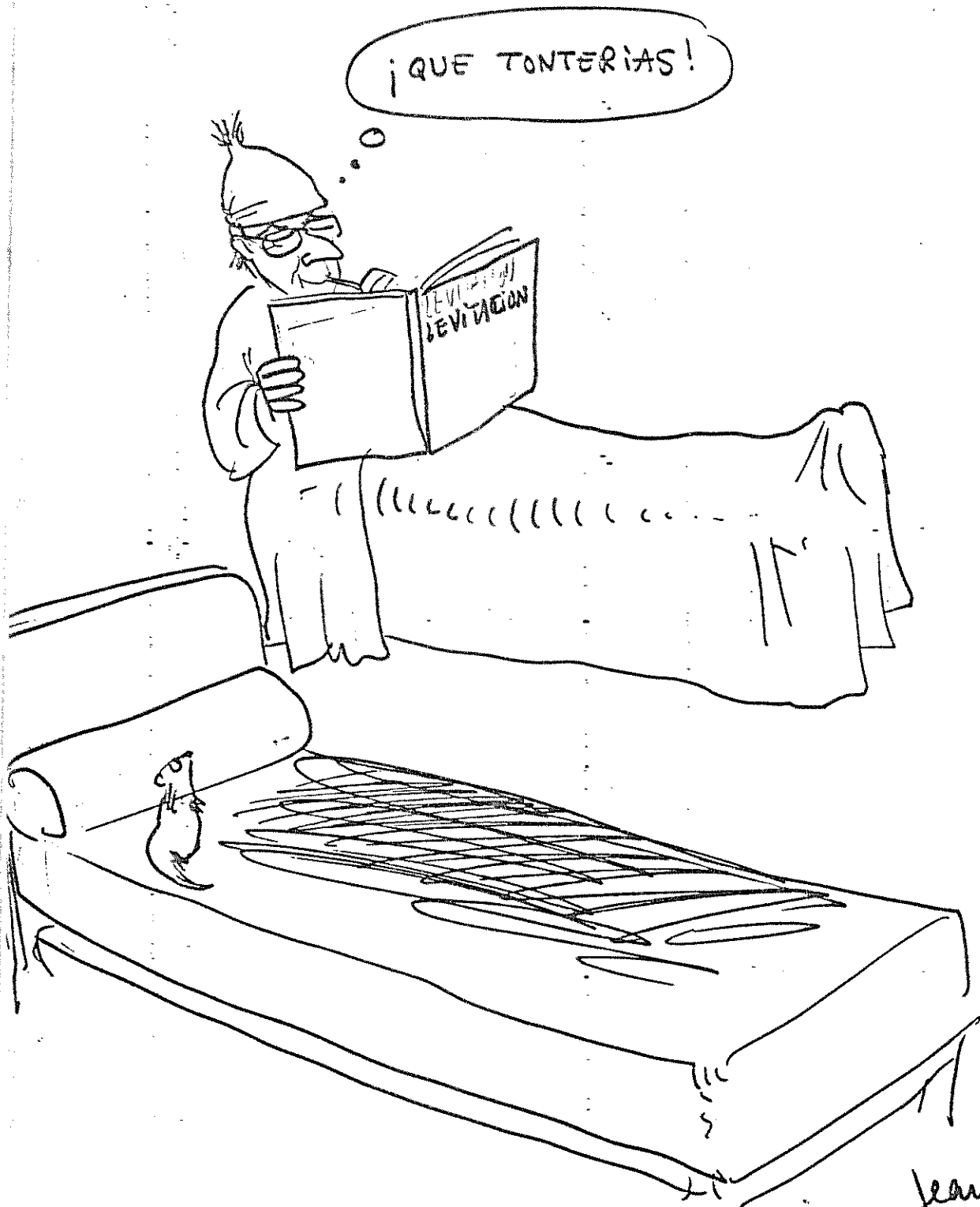

Jean P. Luc

La loi du 11 mars 1957 n'autorise que les « copies ou reproductions strictement réservées à l'usage privé du copiste et non destinées à une utilisation collective ». Toute représentation ou reproduction, intégrale ou partielle, faite sans le consentement de l'éditeur est illicite. Cette représentation ou reproduction, par quelque procédé que ce soit, constituerait donc une contrefaçon sanctionnée par les articles 425 et suivants du Code pénal.

© Éditions Belin 1989

ISBN 2-7011-1277-X

RAFAEL, et les apparitions  
de la neige ?

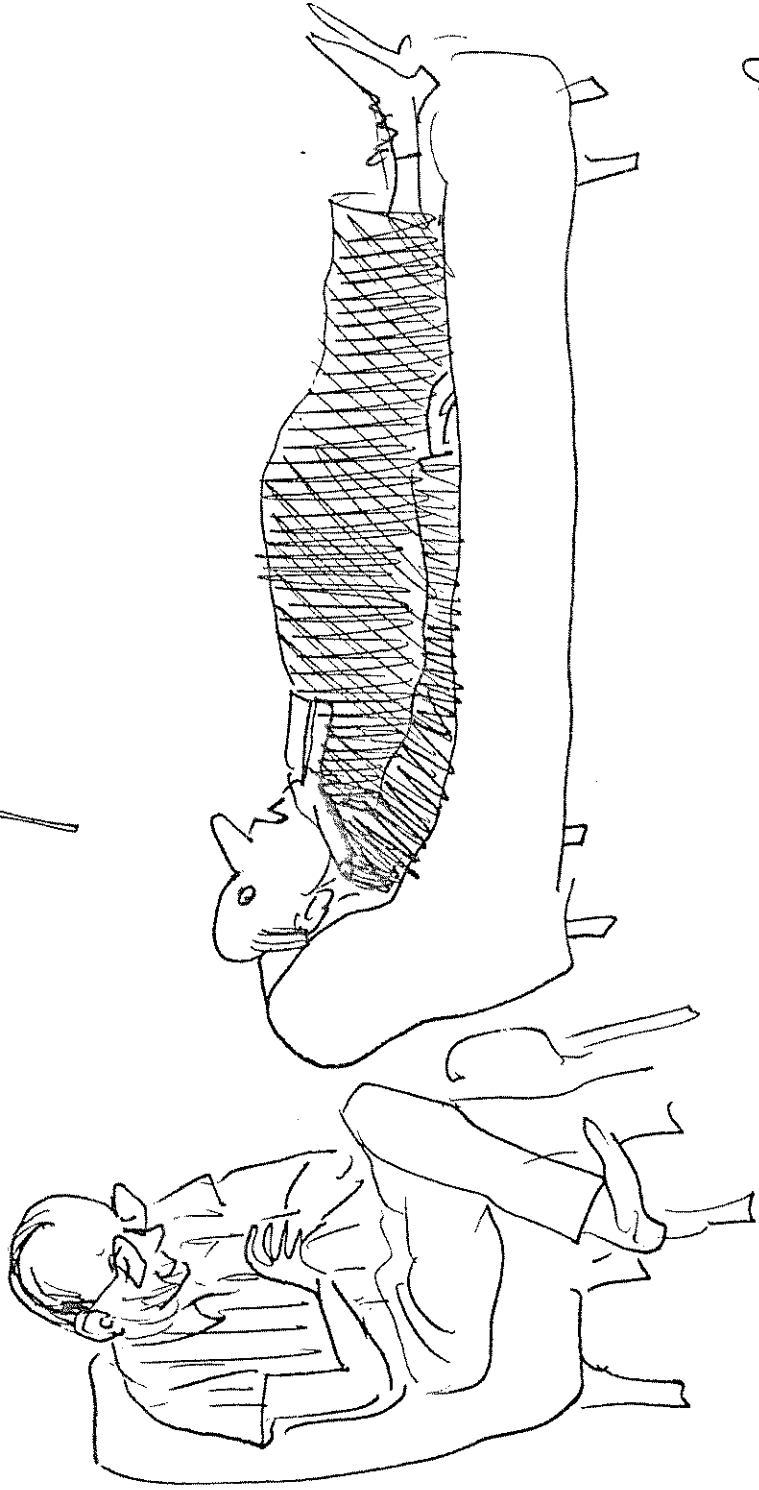

Jean Pica  
sept 88



Ka Piene 1990





Los Ummitas viendo  
los chistes de Jean-Pierre

EL FINAL (?)

CUANTO TIEMPO?

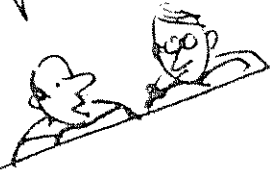

Jean Pierre Petit

A TU ENTEUDEFER,  
CUANTO RATO UDN A  
TARDAR?

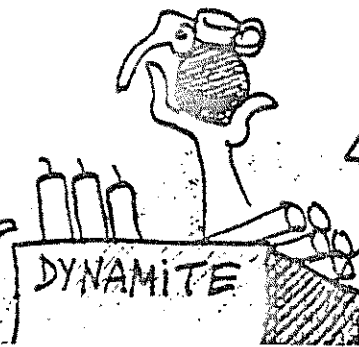

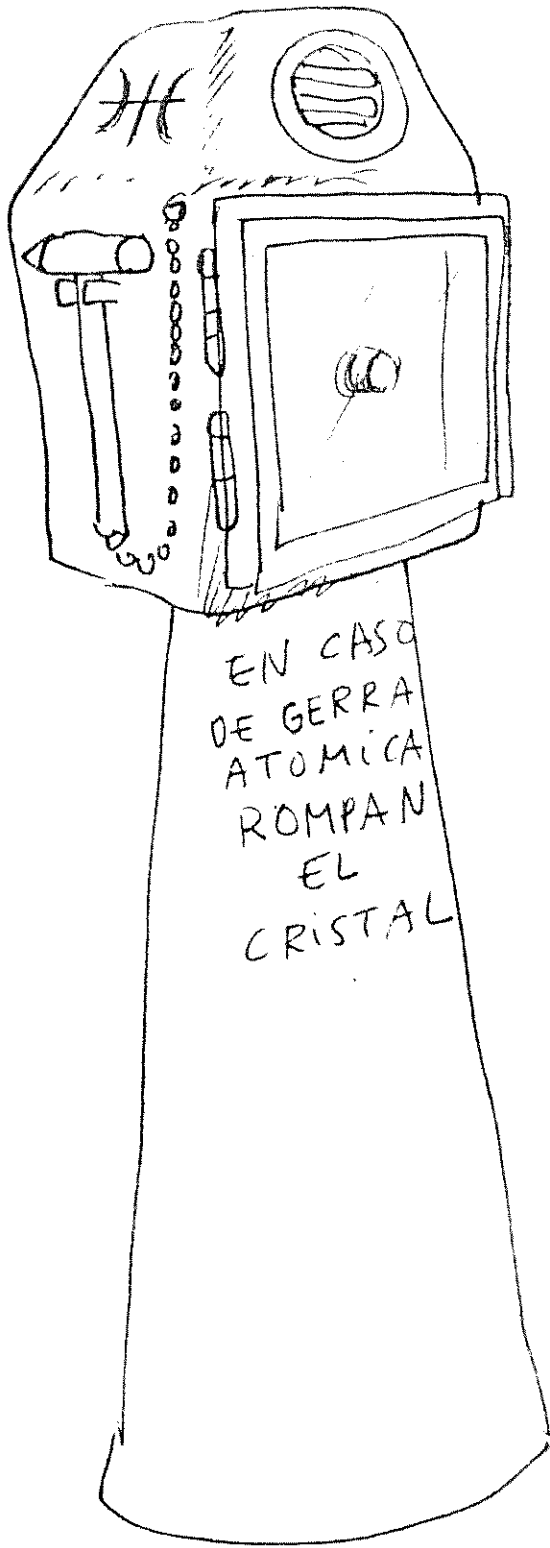

EN CASO  
DE GERRA  
ATOMICA  
ROMPAN  
EL  
CRISTAL



NO HAY NADA  
MAS QUE VER.  
REGRESEMOS.

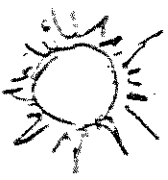

# DIBUJOS



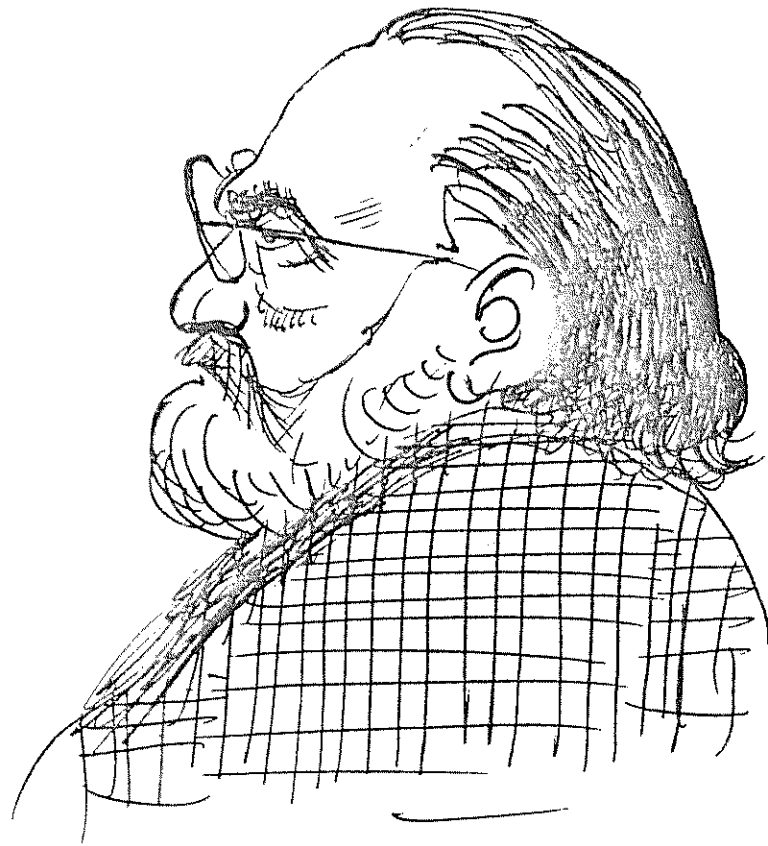



Madame Dominguez

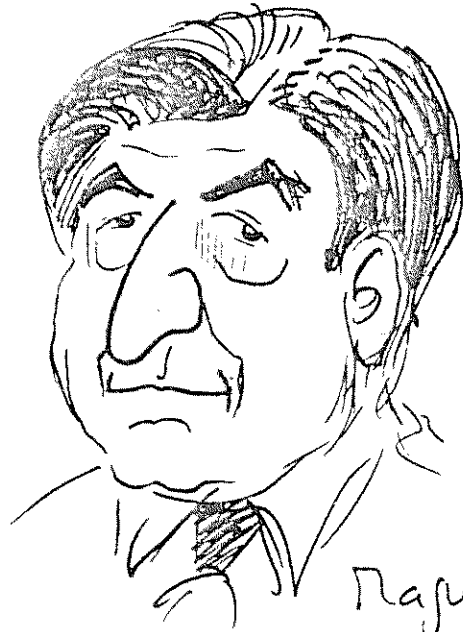

Rapenda



Ribera

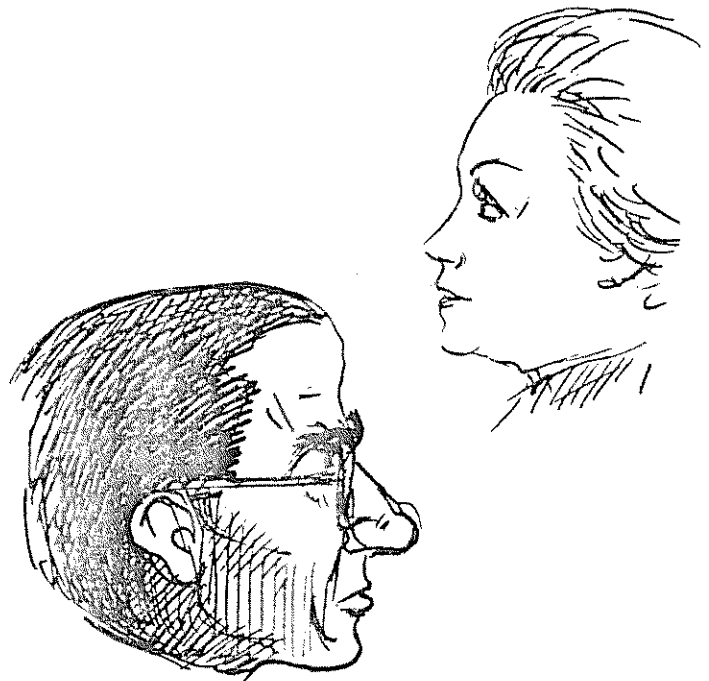

DARNAUDE

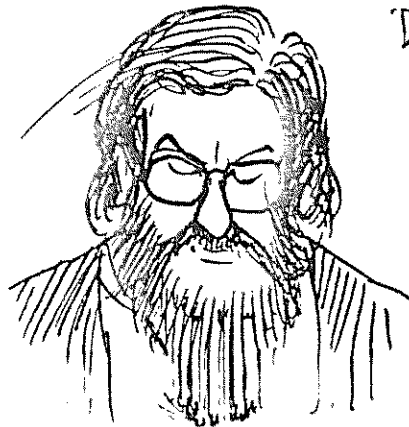
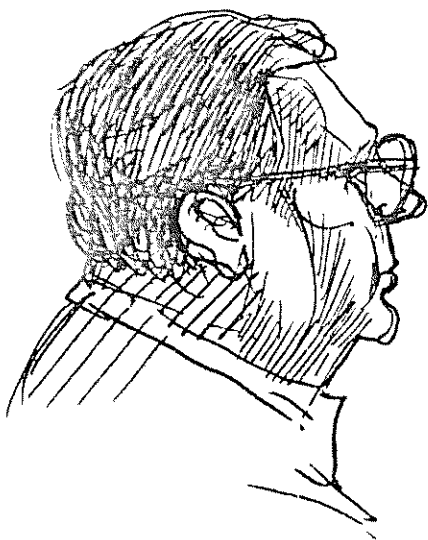

BARRENECKÉ A MUELA

DIBUJOS EN "EL BOSQUE" POR JEAN-PIERRE PETIT

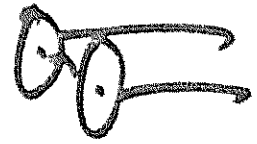
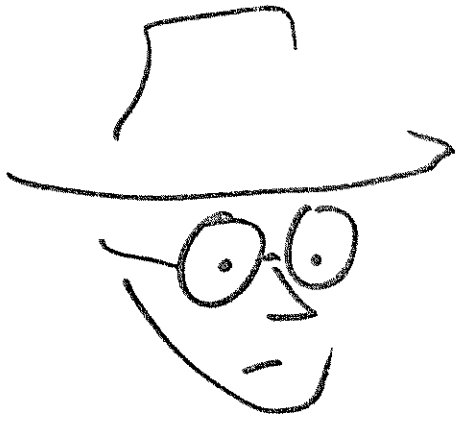

ANSELME  
LANTURLU



MAX

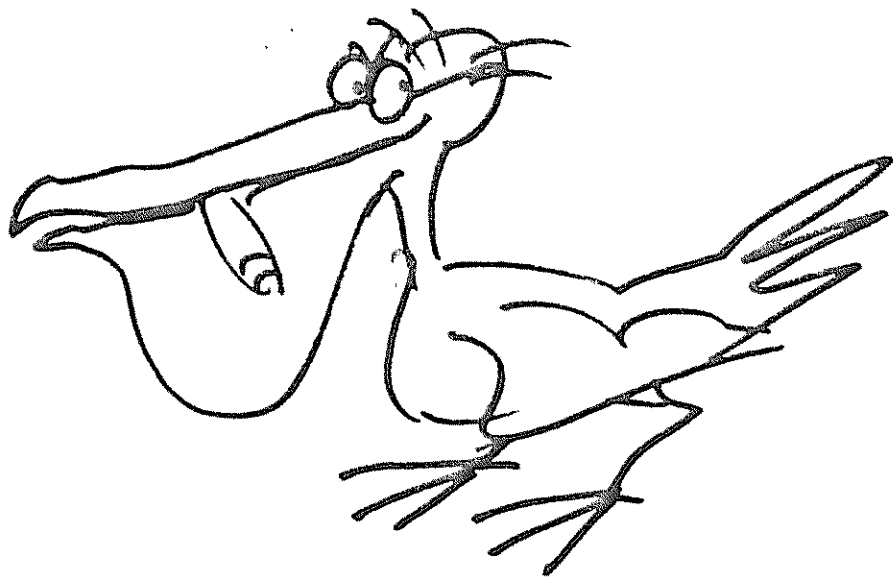

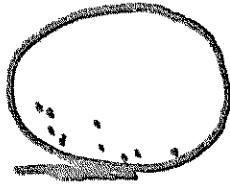
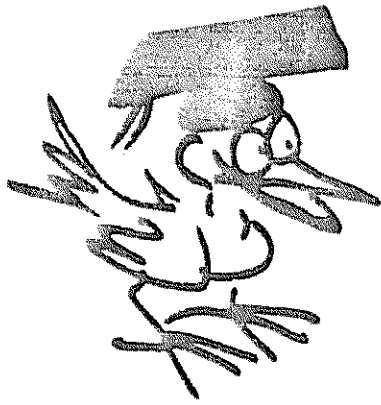





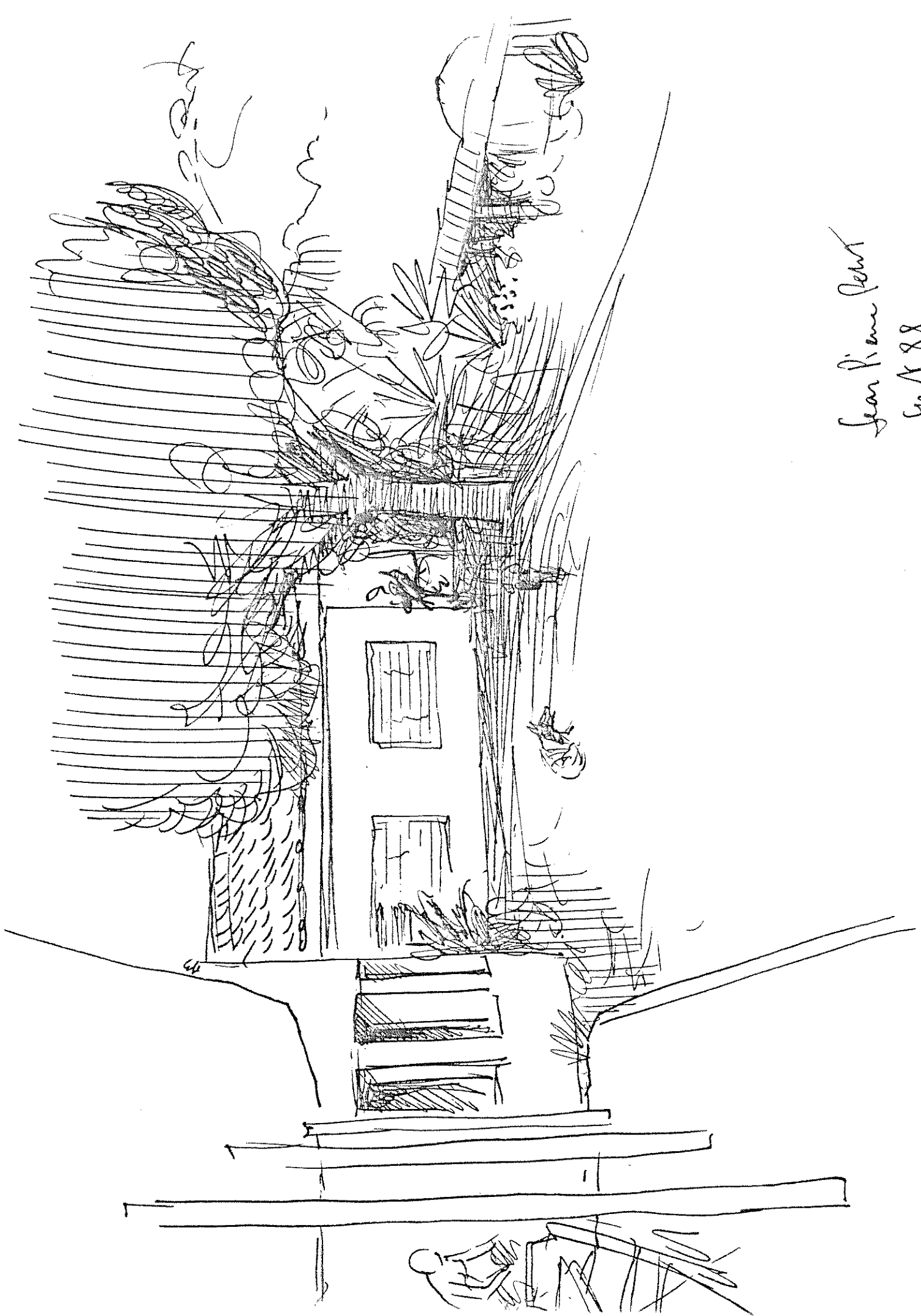

front

Jean Pierre Perrot  
Sept 88



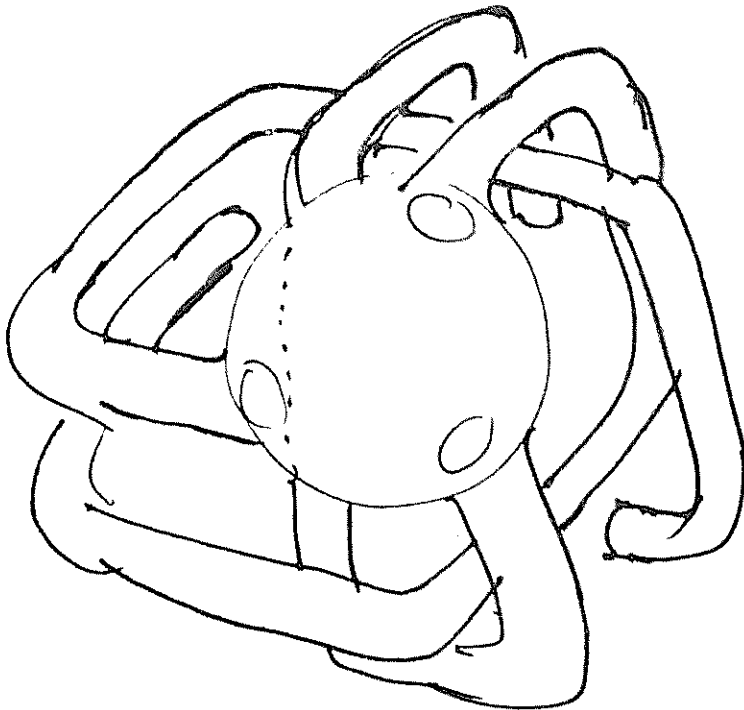
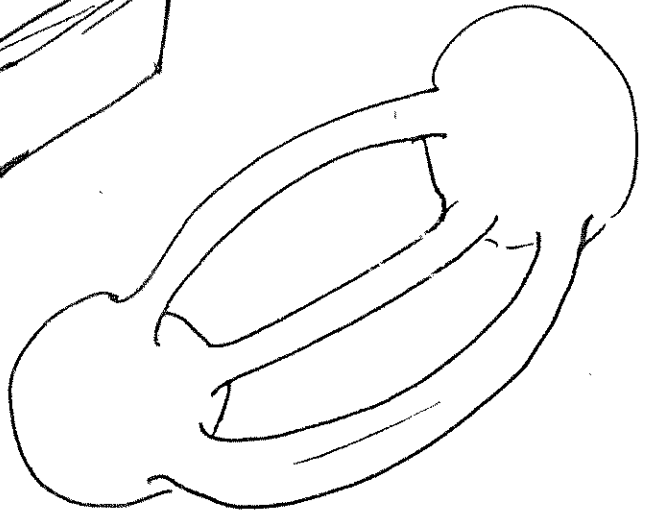
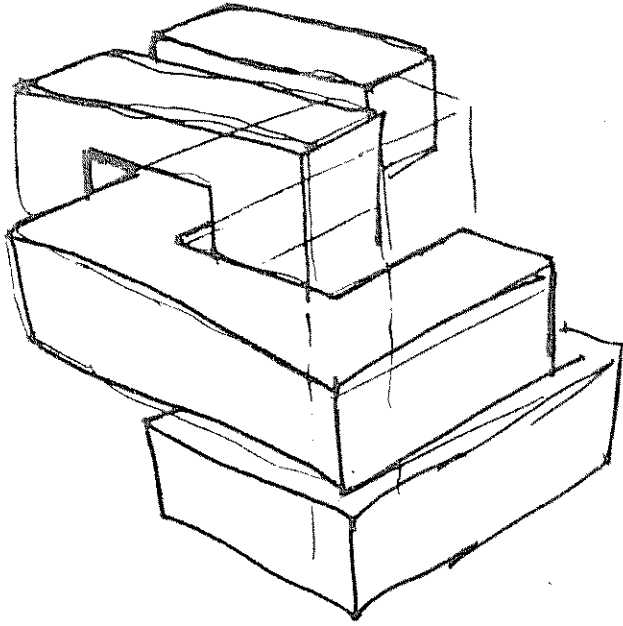

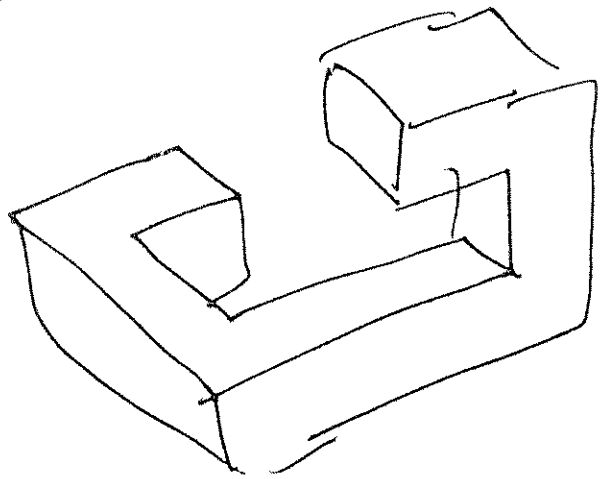
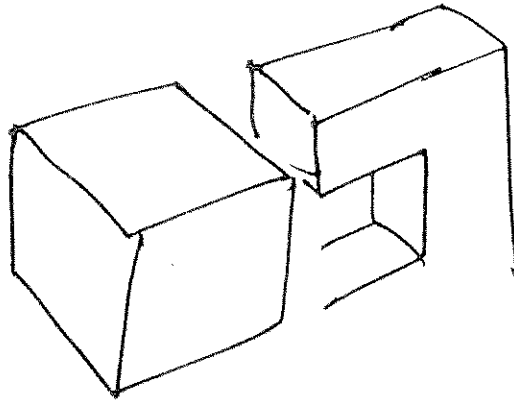
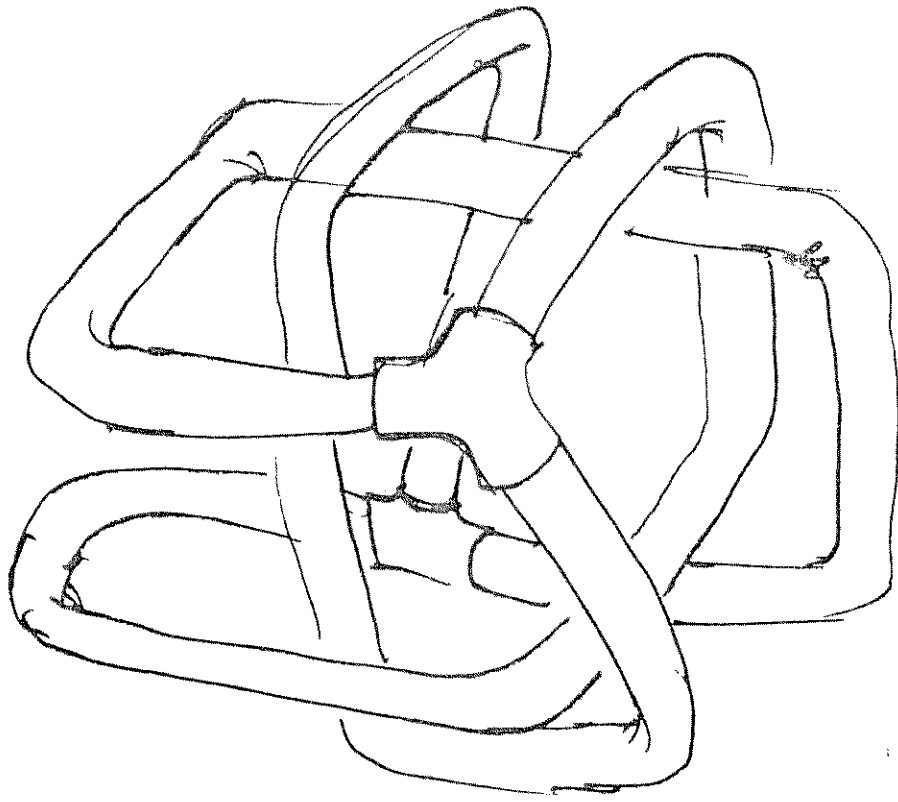

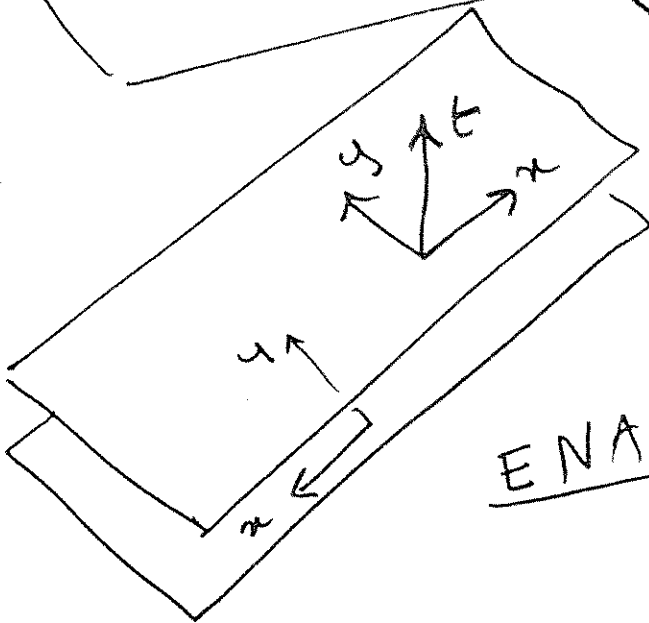
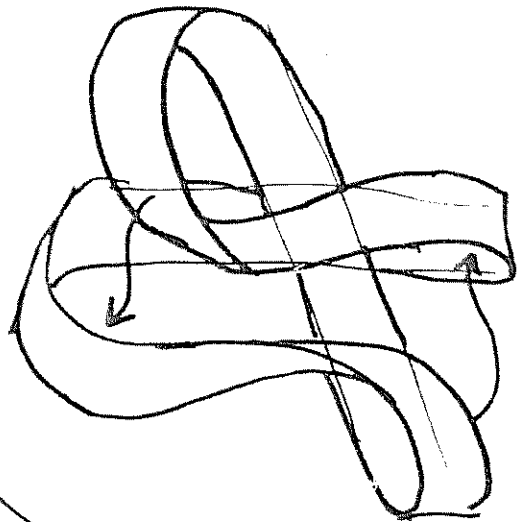
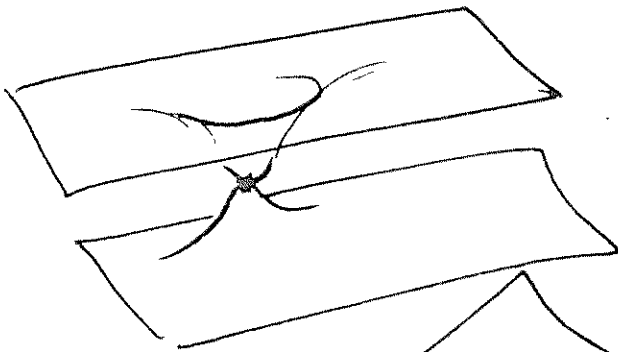
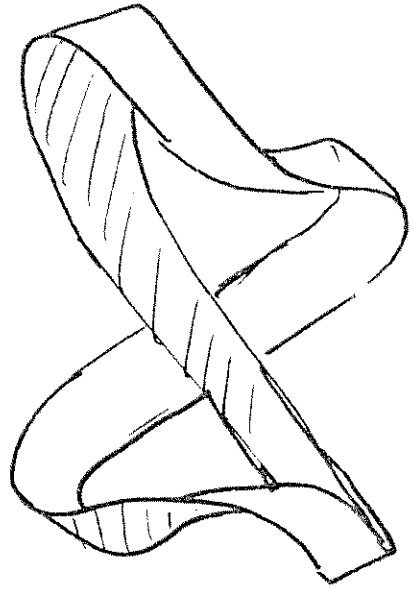
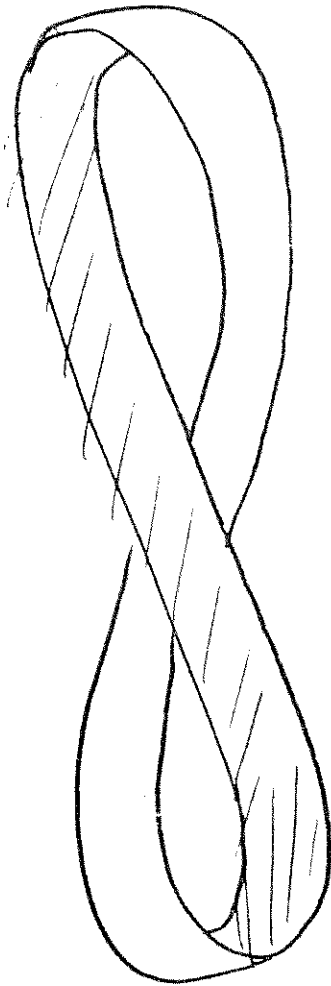

ENANTIOMORPHIC